

LBB SERIES OVEN OWNER'S MANUAL

C-188
PN 336979
VERSION 20
4/2018



SERVICE AND TECHNICAL SUPPORT

service parts: 1-800-473-7373
International service/main: 1-952-469-8230
service fax: 1-952-469-8193
service@despatch.com
usparts@itweae.com

GLOBAL HEADQUARTERS

main phone: 1-800-726-0110
International/main: 1-952-469-5424
sales: 1-800-726-0550
International/sales: 1-952-469-8240
sales@despatch.com

www.despatch.com

8860 207th Street West
Minneapolis, MN 55044 USA

Despatch

Thermal Processing Technology ITW EAE

Revision History

Revision	Date	Author	Description
C			Updated electrical drawings in DRAWINGS AND SPARE PARTS LISTS section.
D			Corrections.
E			Correction, page 19, set-up parameter table
F			Parts lists corrections in DRAWINGS AND SPARE PARTS LISTS section
G			Corrections to SPECIFICATIONS section, addition of options and features in APPENDIX
H			Change Product Warranty page
I			Update drawings and High Limit information
J			Parts lists corrections in DRAWING AND SPARE PARTS LISTS section. Corrected Despatch address.
K			Parts lists corrections in DRAWING AND SPARE PARTS LISTS section
L			Updated warranty
12	3/2011	Livingston	Revise format
13	9/2011	Livingston	Additional parts tables
14	6/2012	Livingston	Update for Protocol 3
15	8/2012	Livingston	Corrections—Power Section.
15	7/2013	Livingston	Corrections—Minor correction to header.
16	8/2013	Meyer	Correction to LBB2-12 spare parts list
17	2/2014	Livingston	Minor copy changes. Remove LBB1-43 references.
17.1	4/2014	Livingston	Revised schematics added plus various small changes.
18	5/2014	E. Anderson	R3 REV -2 modifications
19	4/2016	E. Anderson	Misc clean-up and formatting
20	4/19/18	T Weller	Misc. updates

WARNING

1. **BEFORE OPERATING THIS EQUIPMENT, CAREFULLY READ INSTRUCTION MANUAL.**
2. **THE USER(S) OF THIS EQUIPMENT MUST COMPLY WITH OPERATING PROCEDURES AND TRAINING OF OPERATING PERSONNEL AS STATED IN THE OCCUPATIONAL SAFETY AND HEALTH ACT (OSHA) OF 1970, SECTION 5, AND THE NATIONAL FIRE PROTECTION ASSOCIATION (NFPA), 86 OF 1985.**
3. **THIS EQUIPMENT IS DESIGNED FOR A SPECIFIED AMOUNT OF VOLATILE. EXCEEDING THIS SPECIFIED AMOUNT COULD RESULT IN AN EXPLOSION. SEE DESIGN SPECIFICATION SIGN FOR EXACT AMOUNT OF VOLATILE, EXHAUST AND FRESH AIR REQUIRED.**
4. **HIGH VOLTAGE** PRESENT ON THIS EQUIPMENT, SERVICE BY AUTHORIZED PERSONNEL ONLY.
5. **DO NOT ATTEMPT ANY SERVICE** ON THIS EQUIPMENT WITHOUT OPENING MAIN POWER DISCONNECT SWITCH.
6. **IN CASE OF FIRE, LEAVE DOOR(S) AS THEY ARE. SHUT OFF ELECTRICITY. SHUT OFF FUEL. CALL THE FIRE DEPARTMENT. STAY AWAY.**

FAILURE TO FOLLOW THESE WARNINGS CAN RESULT IN PROPERTY DAMAGE, INJURY, OR DEATH.

Despatch

8860 207th Street, W., Lakeville, MN 55044, USA • 952/469-5424 • FAX 952-469-4513

OM-5 (1/04)

WARNING – READ BEFORE OPERATING UNIT

**FAILURE TO HEED THIS WARNING CAN RESULT IN
PROPERTY DAMAGE, SERIOUS BODILY INJURY OR DEATH**

HI-LIMIT CONTROLS

We Recommend A Hi-Limit control for All Ovens and Furnaces

**A HI-LIMIT CONTROL IS INCLUDED ON THIS UNIT,
IT IS INSTALLED TO PROTECT THE EQUIPMENT.**

The location of the Hi-Limit Sensor element is at the supply duct louver and has been chosen to supervise that temperature. The Hi-Limit instrument should be set approximately 10 to 20 degrees F., higher than the maximum operating temperature. This setting will eliminate nuisance shutdowns when operating at the maximum temperature of the unit and still give maximum protection to the oven or furnace.

**DESPATCH INDUSTRIES CANNOT BE RESPONSIBLE FOR EITHER THE PROCESS
OR THE QUALITY OF THE PRODUCT BEING PROCESSED.**

If the product on which the equipment is being used is critical of over temperature the Hi-Limit should be used as a "Process Hi-Limit." The sensor element is located on the supply duct where the hot air enters work chamber. The temperature setting on the "Process Hi-Limit" should be set somewhat below the temperature at which the product would be damaged. If the product has an ignition temperature at which it could ignite, the setting should be well below this temperature. It is recommended that a certified instrument be used to make the proper setting.

**IT IS THE PURCHASER'S RESPONSIBILITY THAT THE "EQUIPMENT HI-LIMIT" AND/OR
THE "PROCESS HI-LIMIT" BE SET PER THE INSTRUCTIONS ON THIS SHEET AND ALSO
THE INSTRUCTION SHEET FOR THE PARTICULAR HI-LIMIT INSTRUMENT FURNISHED
WITH THIS UNIT.**

Table of Contents

- 1. About This Manual..... 8
 - 1.1. Important User Information..... 8
 - 1.2. Manufacturer & Service 9
 - 1.3. Organization of this Manual 9
 - 1.4. Conventions 10
 - 1.5. Specifications 11
 - 1.5.1. Dimensions 11
 - 1.5.2. Capacities 12
 - 1.5.3. Power..... 13
 - 1.5.4. Temperature..... 14
 - 1.5.5. LBB Series Oven Operating Conditions 14
- 2. Safety..... 15
 - 2.1. Safety Information..... 15
 - 2.1.1. Lockout..... 15
 - 2.1.1.1. Lockout Requirements..... 15
 - 2.1.1.2. Lockout Procedure..... 15
 - 2.2. Provisions for Lifting and Carrying..... 16
 - 2.3. Maintenance 16
 - 2.4. Electrical Power..... 16
 - 2.5. Fire..... 17
 - 2.6. Equipment Lockout Requirements 17
 - 2.6.1. Emergency Stop..... 18
 - 2.7. Disconnecting Devices 18
 - 2.7.1. Power Requirements..... 18
 - 2.7.2. Disconnecting Hard-Wired Units 18
 - 2.7.3. Disconnecting Corded Units..... 19
 - 2.7.4. Disconnecting Units with (Optional) Disconnect Switch..... 19
- 3. Theory of Operation 20
 - 3.1. The LBB Series Oven..... 20
 - 3.1.1. Oven Theory 21
 - 3.2. Control Systems..... 21
 - 3.2.1. Primary Control Instrument..... 21
 - 3.2.2. High Limit Instrument 22
 - 3.2.2.1. Product High Limit Instrument..... 23
 - 3.2.2.2. Oven High Limit Instrument 23
 - 3.3. The Protocol 3 Controller (Optional) 23
- 4. Assembly & Setup..... 24
 - 4.1. Unpack & Inspect the LBB Series Oven 24
 - 4.1.1. If Damaged During Shipping 24
 - 4.2. Set-up the LBB Series Oven..... 24
 - 4.2.1. Select Oven Location/Operating Environment..... 24
 - 4.2.2. Set-up Procedure 25
 - 4.2.3. Wiring & Power Connections 25
- 5. Operation..... 28
 - 5.1. Load Oven 28
 - 5.2. Pre-Startup Checklist..... 29
 - 5.3. Operating Procedure—Standard Control Instrument 30
 - 5.3.1. Start Oven..... 30
 - 5.4. Working with the Control Instrument 32
 - 5.4.1. Change Setpoint..... 32

5.4.2.	Control Instrument Parameter Programming Mode	33
5.4.2.1.	Entering Control Instrument Set-up and Configuration Mode	33
5.4.2.2.	Control Instrument Operating Mode Notes	34
5.4.3.	Change Control Instrument Display from Centigrade to Fahrenheit.....	35
5.4.4.	Oven Zone Calibration	36
5.4.5.	Set the High Limit	37
5.4.5.1.	Change the High Limit Instrument Setpoint.....	37
5.4.6.	High Limit Instrument Parameter Setup Mode	37
5.4.7.	High Limit Instrument Setup Parameters	38
5.4.8.	Change High Limit instrument Display from Centigrade to Fahrenheit	39
5.5.	Working with Optional Protocol 3 Controller Operating Modes	39
6.	Maintenance	40
6.1.	Checklist.....	40
6.2.	Lubrication	41
6.3.	Cleaning and Decontamination	41
6.3.1.	Cleaning the LBB Series Oven.....	41
6.3.2.	Decontaminating the LBB Series Oven.....	42
6.4.	Routine Tests	42
6.4.1.	Test Control Instrument.....	43
6.4.2.	Test High Limit Instrument	43
6.5.	Replacement Parts	44
6.5.1.	Replace the Control Instrument.....	45
6.5.2.	Replace High Limit Instrument	48
6.5.3.	Replace (Optional) Protocol 3 Controller.....	50
6.5.4.	Replace Heater Unit	50
6.5.5.	Replace Fan Motor	52
7.	Troubleshooting.....	55
Table 7.	Common Technical Issues and Remedies	55
7.1.	DES2000 Control Parameters Check	56
7.2.	Hi Limit L91 Hi-Limit Reset.....	58
8.	Appendices	59
8.1.	Standard Products Warranty	59
8.2.	Optional Equipment.....	60
8.2.1.	Assemble Oven Stand.....	60
8.2.2.	End of Cycle (EOC) Timer Option.....	61
8.2.3.	Operating the Timer	62
8.2.4.	Parameter Default Settings	64
8.2.5.	Timer Option with Audible and Visual Alarm.....	64
8.2.6.	High Alarm Limit Option	64
8.3.	Part Lists.....	65
8.4.	Mechanical Drawing	65
8.5.	Electrical Schematics.....	65

Figures

Figure 1. Disconnect Switch.....	19
Figure 2. LBB Forced Convection Benchtop Oven.	20
Figure 3. Uniflow Airflow through the LBB Oven.	20
Figure 4. LBB Series Oven Primary Control Instrument	21
Figure 5. High Limit Instrument.	22
Figure 6. Protocol 3 Operator Interface.....	23
Figure 7. LBB Series Oven Name Plate Example.....	26
Figure 8. LBB Series Oven with Top Removed.....	26
Figure 9. Wiring Access through Rear of Oven.	27
Figure 10. Close-up of Connector Block.....	27
Figure 11. LBB Series Oven Control Panel.	31
Figure 12. Adjust Damper to Set Exhaust Vent by rotating the outer component.	31
Figure 13. Remove Control Panel to Access Control Instrument (using T20 Torx bit driver).	45
Figure 14. Providing easy access to the Control instrument.	46
Figure 15. Remove old Control and High Limit Instruments and Wiring (Rear View).....	46
Figure 16. Prepare to remove control instrument by removing the mounting bracket.....	47
Figure 17. Connections to Control Instrument.	47
Figure 18. High Limit Connector Block on Control Board.....	48
Figure 19. Press and Hold Tabs to Remove High Limit Instrument.	49
Figure 20. Connections to High Limit Instrument.	49
Figure 21. Remove Screws to Remove Each Duct (using T15 Torx bit driver.....	50
Figure 22. Heater element connections.	51
Figure 23. Typical Heating Element (Inset connections see Figure 22)	52
Figure 24. Fan Motor Location.	53
Figure 25. Separate fan wheel from fan motor shaft.	54
Figure 26. Optional LBB Oven Stand.	60
Figure 27. Timer Option Displays and Switches.....	61

Tables

Table 1. Operating/Environmental Conditions (For indoor use).....	14
Table 2. Control Instrument Explanations.....	22
Table 3. High Limit Instrument Explanations.....	22
Table 4. Control Instrument Set-up Parameters.	33
Table 5. Control Instrument Configuration Parameters.	34
Table 6. High Limit instrument Setup Parameters.	38
Table 7. Common Technical Issues and Remedies.	55

1. About This Manual

1.1. Important User Information

Copyright © 2018 by Despatch Industries.

All rights reserved. No part of the contents of this manual may be reproduced, copied, or transmitted in any form or by any means including graphic, electronic, or mechanical methods or photocopying, recording, or information storage and retrieval systems without the written permission of the publisher, unless it is for the purchaser's personal use.

Produced in the United States of America.

The information in this manual is subject to change without notice and does not represent a commitment on the part of Despatch Industries. Despatch Industries does not assume any responsibility for any errors that may appear in this manual.

In no event will Despatch Industries be liable for technical or editorial omissions made herein, nor for direct, indirect, special, incidental, or consequential damages resulting from the use or defect of this manual.

	<p>Values displayed on screens are examples only. Though those values may be typical, contact Despatch Industries for the final value.</p>
---	---

	<p>Users of this equipment must comply with operating procedures and training of operation personnel as required by the Occupational Safety and Health Act (OSHA) of 1970, Section 5 and relevant safety standards, as well as other safety rules and regulations of state and local governments. Refer to the relevant safety standards in OSHA and National Fire Protection Association (NFPA), section 86 of 1990.</p>
---	--

	<p><i>Danger!</i></p> <p><i>Only fully-trained and qualified personnel should setup and maintain this equipment. Improper setup and operation of this equipment could cause an explosion that may result in equipment damage, personal injury or possible death.</i></p>
---	--

The information in this document is not intended to cover all possible conditions and situations that might occur. The end user must exercise caution and common sense when installing or maintaining Despatch Industries products. If any questions or problems arise, call Despatch Industries at **1-800-762-0110** or **1-952-469-5424**.

1.2. **Manufacturer & Service**

The LBB Series oven is manufactured by Despatch Industries.

Despatch has specialized in thermal processing for over 100 years. Technical expertise gained over those years helps provide innovative solutions to critical applications in vertical markets and cutting edge technology worldwide. Despatch products are backed by a drive for long-term customer satisfaction and a strong sense of responsibility. The worldwide network of factory-trained Service Professionals is available to support your Despatch equipment. From full service preventive maintenance to routine repair and certified calibration and uniformity, the Despatch service network is positioned to respond to your business needs. Our service programs are customized to meet your specific needs using our Advantage Service Assurance Program (ASAP). For more information on ASAP, visit **www.despatch.com**.



Global Headquarters	Contact	Service & Technical Support
Despatch Industries 8860 207th Street Lakeville, MN 55044 USA	International/Main: 1-952-469-5424 US toll free: 1-800-726-0110 Fax: 1-952-469-4513 info@despatch.com www.despatch.com	Service: 1-952-469-8230 US toll free: 1-800-473-7373 Service @despatch.com

1.3. **Organization of this Manual**

This owner's manual contains the most comprehensive set of information for the Despatch LBB Series ovens, including installation instructions, theory of operation, and operating instructions, among other things.

	<p><i>Danger!</i></p> <p><i>Failure to heed warnings in this instruction manual and on the oven could result in personal injury, property damage or death.</i></p>
---	---

1.4. Conventions

	<p><i>This icon signifies information that describes an unsafe condition that may result in death, serious injury, or damage to the equipment.</i></p>
<p>Danger!</p>	<p><i>Danger is the signal word used to indicate a hazardous situation that, if not avoided, will result in death or severe injury.</i></p>
<p>Warning!</p>	<p><i>Warning is the signal word used to indicate a hazardous situation that, if not avoided, could result in death or severe injury.</i></p>
<p>Caution!</p>	<p><i>Caution is the signal word used to indicate a hazardous situation that, if not avoided, could result in moderate or minor injury.</i></p>
<p>Notice</p>	<p><i>Notice is the signal word used to indicate a hazardous situation that, if not avoided, could result in property damage.</i></p>
	<p><i>This icon signifies important supplemental information.</i></p>
<p>LOG OUT</p>	<p><i>Bold, 10 point sans-serif typeface indicates a specific key or button on screen to click.</i></p>

1.5. Specifications

1.5.1. Dimensions

LBB Model No.	Chamber Size in (cm)			Capacity feet ³ (liters)	Overall Size in (cm)			Shelves Provided on Shelf Centers in (cm)	Maximum Number of Shelf Positions	Chamber Doors
	W	D	H		W	D	H			
1-23	18 (46)	18 (46)	12 (30)	2.3 (65)	24 (61)	26 (66)	26 (67)	2 on 2" (5)	5	1
1-69	30 (76)	18 (46)	22 (56)	6.9 (195)	36 (92)	26 (65)	36 (92)	2 on 2" (5)	10	2
2-12	30 (76)	20 (51)	35 (89)	12.1 (343)	36 (91)	28 (71)	51 (131)	2 on 2" (5)	16	2
2-18	37 (94)	24 (61)	35 (89)	18 (510)	43 (109)	32 (81)	51 (130)	2 on 2" (5)	16	2
2-27	37 (94)	37 (94)	35 (89)	27.7 (784)	43 (109)	45 (114)	51 (130)	2 on 2" (5)	16	2

NOTE – refer to assembly drawing for exact dimensions



The LBB oven is not intended to process solvents or other volatile or flammable materials. Oven exhaust is intended for cooling purposes only.



Warning!

Do not place this oven in an environment harmful to electrical components.

Placing this oven in an environment detrimental to electrical components (for example, environments where carbon fibers, coal dust or similar contaminants may be present) may result in component failure.

Do not use liquids in the oven. Do not set product or liquids on top of the oven. Liquids that may spill on the oven floor or top of oven may cause considerable damage to the oven.

Contact Despatch for options available to help prevent such failures.

1.5.2. Capacities

Capacity	LBB Model Number				
	1-23	1-69	2-12	2-18	2-27
Maximum Load Lbs (Kg)	200 (91)	400 (181)	600 (272)	600 (272)	600 (272)
Maximum Shelf Load Lbs (Kgs)	50 (23)	200* (91)	200* (91)	200* (91)	200* (91)
Exhaust Capacity CFM (LPS)	1 (0.5)	3 (1.4)	12 (5.7)	14 (6.6)	14 (6.6)

*LBB1-69 and larger models have reinforced shelves.

	<p>Maximum load capacity not valid on ovens with the “control panel located on bottom” option.</p>
---	---

	<p>Warning!</p> <p>Do not exceed a total of 400 Lbs. (181 Kg) for stacked LBB1-69 ovens.</p>
---	--

1.5.3. Power

If the line voltage for your LBB Series oven varies more than 10% from the oven voltage rating, electrical components such as relays and temperature controls may operate erratically.

- If the line voltage is lower than the oven voltage rating, heat-up time may be significantly longer and motors may overload or run hot.
- If the line voltage is higher than the nameplate rating, motors may run hot and draw excessive amperage.

Model	Volts	Amps	Hertz	Phase	Heater KW	Cord and Plug
LBB 1-23	120	11.6	50/60	1	1.2	Included, 15 Amp
LBB 1-23	240	5.8	50/60	1	1.2	Included, 15 Amp
LBB 1-69*	120	21.6	50/60	1	2.4	None, Hardwired
LBB 1-69*	240	10.8	50/60	1	2.4	None, Hardwired
LBB 2-12*	240	16.6	50/60	1	3.6	None, Hardwired
LBB 2-18*	240	16.7	50/60	1	3.6	None, Hardwired
LBB2-27*	240	21.7	50/60	1	4.8	None, Hardwired

* Models LBB1-69, LBB2-12, -18 and -27 must be hardwired to the electric supply using 10 AWG or larger wire suitable for at least 75 °C (167 °F).





Ovens designed for 240 volts (check your oven nameplate for power requirement) will operate satisfactorily on a minimum of 208 volts, but with a 25% reduction in heater power. If your power characteristics are lower, contact Despatch industries.

1.5.4. Temperature

Temperature and Parameters		LBB Model Number				
		1-23	1-69	2-12	2-18	2-27
Time to temperature (approximate minutes with no load)	40°C-150°C	17	15	15	17	17
	40°C-204°C	31	29	26	33	33
Recovery time with door open 1 minute (approximate minutes with no load) *	150°C	2	3	3	3	4
	204°C	4	6	6	7	8
Temperature uniformity at:	150°C	+/- 3°C	+/- 3°C	+/- 2°C	+/- 3°C	+/- 3°C
	204°C	+/- 4°C	+/- 4°C	+/- 3°C	+/- 4°C	+/- 4°C
Operating range with 20°C ambient:		35°C- 204°C			40°C-204°C	
Control stability		± 0.5 °C				

*Recovery time as measured at control thermocouple.

	<i>Dampers must be open to operate at the minimum temperature.</i>
--	---

	<i>“Time to Temperature” and “Temperature Uniformity” values are based on 240V/60 Hz operation, with control panel located on top. Actual results may vary slightly depending on unit configuration and operating conditions.</i>
---	--

1.5.5. LBB Series Oven Operating Conditions

The LBB Series oven is for indoor use. Table 1 provides the operating conditions.

Table 1. Operating/Environmental Conditions (For indoor use).

Item	Description
Operating Temperature*	18°C to 40°C (64.4°F to 104°F)
Relative Humidity	70% non-condensing
Maximum Altitude	2,000 meters (6,600 feet)

* Fluctuations in temperature can occur at elevated ambient temperature values.

2. Safety

2.1. Safety Information

Do not work on the LBB Series oven without reading and understanding this section, which contains important information and warnings. Ignoring these warnings can result in death, serious injury or damage to the machine and product.

2.1.1. Lockout



Carefully follow the established Lock Out Tag Out policies of your company in all cases.

Machine lockout places the LBB Series oven into a zero energy state and prevents accidental machine start up. Always follow the Lockout Procedure described in this section before cleaning, maintaining or repairing the LBB Series oven. An accidental start-up, while working on the LBB Series oven, can result in serious injury or death.

2.1.1.1. Lockout Requirements

1. Every power source that can energize any element of the LBB Series oven must be shut off at the closest possible power source. This includes air, water and electricity, including the Disconnect Switch.
2. After energy sources are locked out, test to ensure circuits are de-energized.

2.1.1.2. Lockout Procedure



Danger!

Electrical panels contain high voltage. Disconnect and lock out the power supply before working inside any electrical panels. Failure to lock out the power supply can result in death or injury.

Personnel authorized to lock out equipment must have the necessary locks to perform the lockout.

1. Physically disconnect all electrical power to the machine or lock out the appropriate breaker or disconnects.
2. Close all valves and bleed off any pressure.
3. Test for power by attempting a start with the machine controls.
4. Identify the Lockout Condition with a tag on the electrical disconnect and pneumatic shut off valve.
5. When work is complete, remove all tags and restore the machine to its working state.

2.2. Provisions for Lifting and Carrying

	<p>Caution!</p> <p><i>Do not tilt oven while lifting. Do not lift oven using the door handle to prevent damage to the oven and/or personnel involved.</i></p>
---	--

	<p>Caution!</p> <p><i>Do not risk injury when lifting equipment. Take proper precautions when lifting, carrying or otherwise maintaining heavy items.</i></p>
---	--

<p>Notice</p>	<p><i>How to lift the different sizes of ovens:</i></p> <ul style="list-style-type: none">• <i>LBB1-23: Four people lift oven's lower corners and place on wheeled transport pallet. Push pallet to desired site and lift oven from pallet, again lift using lower corners.</i>• <i>LBB1-69, LBB2-12, LBB2-18, LBB2-27: Do not lift by hand. Lift with fork lifter and transport pallet.</i>
---------------	---

2.3. Maintenance

Only qualified and trained personnel should perform maintenance or repair.

2.4. Electrical Power

Only qualified and trained personnel should perform electrical maintenance or electrical repair.

	<p>Danger!</p> <p><i>Contact with energized electrical sources may result in serious injury or death.</i></p>
---	--

- Before performing maintenance, disconnect all electrical power from the machine. Use a padlock and lock out all disconnects feeding power to the machine.
- Never clean or repair the oven when in operation.
- Unauthorized alterations or modifications to LBB Series oven are strictly forbidden. Never modify any electrical circuits. Unauthorized modifications can impair the function and safety of the LBB Series oven.

	<p>Warning!</p> <p><i>Do not place this oven in an environment harmful to electrical components.</i></p> <p><i>Placing this oven in an environment detrimental to electrical components (for example, environments where carbon fibers, coal dust or similar contaminants may be present) may result in component failure.</i></p> <p><i>Do not use corrosive liquids or flammable solvents in the oven. Do not set product or liquids on top of the oven. Liquids that may spill on the oven floor or top of oven may cause considerable damage to the oven.</i></p> <p><i>Contact Despatch for options available to help prevent such failures.</i></p>
---	--

2.5. Fire

Keep the LBB Series oven clean and free of scrap materials, oil or solvents to prevent the possibility of fire. In the event of fire:

1. Leave door (s) as they are.
2. De-energize the machine immediately by turning OFF the **DISCONNECT SWITCH** or removing all power.
3. Turn off the remote main disconnect (customer supplied disconnect).
4. Shut off fuel
5. Call the fire department or use a fire extinguisher to extinguish the fire.

	<p>Danger!</p> <p><i>Always disconnect all power before extinguishing a fire. Attempting to extinguish a fire in a machine connected to electrical power can result in serious injury or death!</i></p>
---	--

2.6. Equipment Lockout Requirements

To prevent injury or equipment damage during inspection or repair, the LBB Series oven must be locked out.

2.6.1. Emergency Stop

When a risk of personal injury or damage to the LBB Series oven exists, turn OFF the oven by either the disconnect switch or removing/unplugging the cord. This shuts off all electrical power to the oven.

2.7. Disconnecting Devices

2.7.1. Power Requirements

Despatch recommends the LBB Series Ovens have unobstructed access to a dedicated power source.



Use a power stabilizer if voltage fluctuation is greater than $\pm 10\%$ nominal voltage fluctuation.

2.7.2. Disconnecting Hard-Wired Units

LBB permanently-connected (hard-wired) ovens include models LBB1-69, LBB2-12, LBB2-18 and LBB2-27. Permanently-connected and multi-phased equipment must employ a switch or circuit-breaker as means for disconnection.

Notice

For permanently-connected equipment, installation instructions must specify a switch or circuit-breaker be included during the facility oven installation for complete isolation.

The disconnecting device must be installed in close proximity to the equipment and within easy reach of the operator. The disconnecting device must be marked as the disconnecting device for the equipment. If the unit is equipped with an ON/OFF switch, mark the ON/OFF position clearly.



Follow local codes and requirements for installing and using disconnect switches.

	<p>Danger!</p> <p><i>Keep switch or circuit-breaker in building installation close to the equipment, within easy reach of the operator and clearly marked.</i></p>
---	---

2.7.3. Disconnecting Corded Units

LBB cord-connected ovens includes model LBB1-23. To disconnect a corded unit, unplug the cord from the power source.

2.7.4. Disconnecting Units with (Optional) Disconnect Switch

The LBB Series oven has an optional Disconnect Switch (Figure 1). This Disconnect Switch is located on the front of the oven and is connected to the load break switch behind the panel that disconnects or connects power from the main line. When a risk of personal injury or damage to the LBB Series oven exists, turn off the Disconnect Switch. This shuts off all electrical power to the oven.



Figure 1. Disconnect Switch.

3. Theory of Operation

3.1. The LBB Series Oven

The Despatch LBB Series ovens (Figure 2) effectively distribute heat with a processing time among the fastest of any lab oven in its class. LBB Series ovens are effectively used in testing, preheating, sterilizing, drying, aging and curing as well as other production applications. The LBB Series ovens incorporate forced circulating airflow with precise digital control to deliver fast processing. The overall result is efficient productivity under strenuous conditions.



Figure 2. LBB Forced Convection Benchtop Oven.

The LBB Series ovens are precise and practical. The unique Despatch design moves convected heat through stainless steel ducts on each side of the oven (Figure 3). The air is circulated with a high volume fan. The LBB Series ovens employ higher volume fans than any competitive model. The chamber can be densely loaded without interfering with the process. For your convenience the fresh air intake is fixed. The exhaust rate is regulated by a damper on the back of the unit.

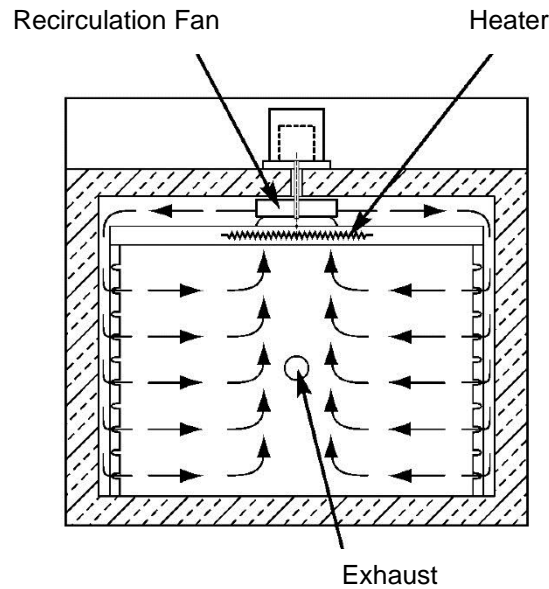



Figure 3. Uniflow Airflow through the LBB Oven.

	<p>Warning!</p> <p><i>Do not remove the hat bracket as it distributes exhaust air and protects the exhaust opening from being completely covered.</i></p>
---	--

3.1.1. Oven Theory

The LBB Series forced circulating oven uses fans to circulate air through the chamber. A circulating oven is a much more efficient and uniform oven than a gravity-convection oven due to the constant air movement. Soaking at a desired setpoint still depends on a number of parameters including chamber area, load mass, the ability to absorb heat and the exhaust rate. But soak times with a forced circulating oven may be shortened.

The LBB Series oven is capable of heating to 204°C (400°F). The oven uses a microprocessor-based digital control to display the actual chamber temperature at the sensing point. The temperature sensor is located to optimize control action for the entire chamber for various load conditions. The control display may fluctuate a few degrees around the setpoint, reflecting temperature changes at the sensor location. However, overall chamber temperature remains stable. The strategic location of the sensor compensates for delays in heat convection and enhances the performance and temperature control of the oven. The oven has been designed for an overall result of quality productivity where fast processing and versatility are critical.

3.2. Control Systems

3.2.1. Primary Control Instrument

The LBB Series oven is equipped with a microprocessor-based digital control instrument configured as a proportional controller and set to its optimum operating values (Figure 4). Initially the control instrument allows the heater to operate at full power. As the actual oven temperature reaches the setpoint, the control instrument cycles the heater on and off, minimizing process temperature fluctuations. Table 2 provides explanation for working with the control instrument.

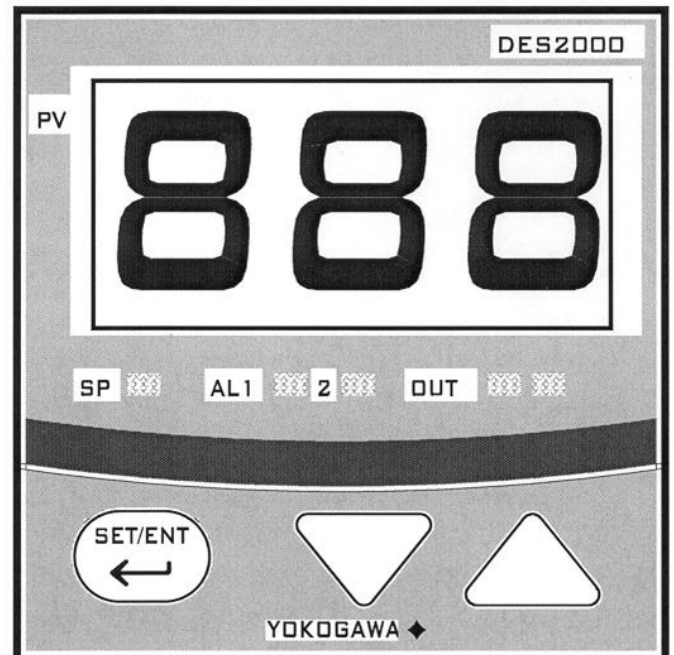



Figure 4. LBB Series Oven Primary Control Instrument

Table 2. Control Instrument Explanations.

Display	Description
Main (PV) Display	Typically displays actual oven temperature. Press SET/ENT to display setpoint. Displays parameter code and value.
 Key	Press to switch between PV and SP displays. Enter data using ▲ or ▼. Press repeatedly to switch through parameter displays.
▼	Decrease setpoint or mode parameter
▲	Increase setpoint or mode parameter
SP	Lit when setpoint value displays
OUT	Lit when control calls for heat
AL1-2	N/A

3.2.2. High Limit Instrument

The LBB Series oven is equipped with a High Limit instrument (Figure 5). The High Limit instrument protects the oven or product by discontinuing the heating process when the High Limit is exceeded.

Set the High Limit instrument to a temperature 10°C - 14°C higher than the control instrument setpoint, or to a temperature that should not be exceeded in the process. If the setting on the High Limit instrument is exceeded, the heater shuts down. See Table 3 for explanation about the High Limit instrument.

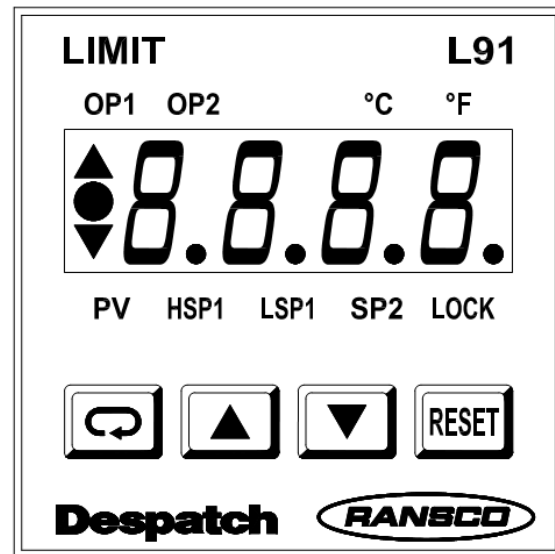



Figure 5. High Limit Instrument.

	Reset the High Limit instrument by pressing RESET on the instrument.
---	---

Table 3. High Limit Instrument Explanations.

Features	Description
OP1	Output 1 status value. (OP2 normally not used for LBB Ovens).
°C/°F	Degree indicator.: Celsius or Fahrenheit
PV	Process value
HSP1	High Limit setpoint 1. (LSP1 typically not used for LBB Ovens).
SP2	Setpoint 2 for output 2 (typically not used for LBB Ovens)
LOCK	Lock status indicator
	Scroll Key, used for advancing available displays

Features	Description
▲	Increases a setpoint or mode parameter
▼	Decreases a setpoint or mode parameter
RESET	Reset the High Limit, return to normal display

3.2.2.1. Product High Limit Instrument

If the product being processed has a critical high temperature limit, use the High Limit instrument as a product High Limit instrument. Set the High Limit instrument to a temperature somewhat below the temperature at which the product could be damaged.

3.2.2.2. Oven High Limit Instrument

If the product being processed does not have a critical high temperature limit, use the High Limit as an oven High Limit instrument to protect the oven equipment. Set the High Limit to 204°C.

3.3. The Protocol 3 Controller (Optional)

The Protocol 3™ controller is a microprocessor based digital temperature controller designed for simple and flexible oven operation (Figure 6). The Protocol 3 controller operates as a dual-functioning controller/High Limit instrument. The control portion utilizes a time proportioning voltage signal to control heating devices with minimal temperature fluctuations.

The High Limit portion protects the product and/or the oven from overheating. If the product being processed has a critical high temperature limit, the High Limit setpoint should be set to a temperature somewhat below the temperature at which the product could be damaged. If the product does not have a critical high temperature limit, the High Limit setpoint should be set 5 to 15 degrees higher than the maximum programmed setpoint at which the oven will operate.

The Protocol 3 controller provides three primary operating modes:

- Manual: Oven operates continuously at a fixed temperature until turned off.
- Timer: Oven operates at a fixed temperature for a user-selected time period, and then automatically turns off.
- Profile: Temperatures increase or decrease as defined by 255 segments that can be allocated to 64 ramp and soak profiles.

The profiles can be linked to provide additional temperature combinations.

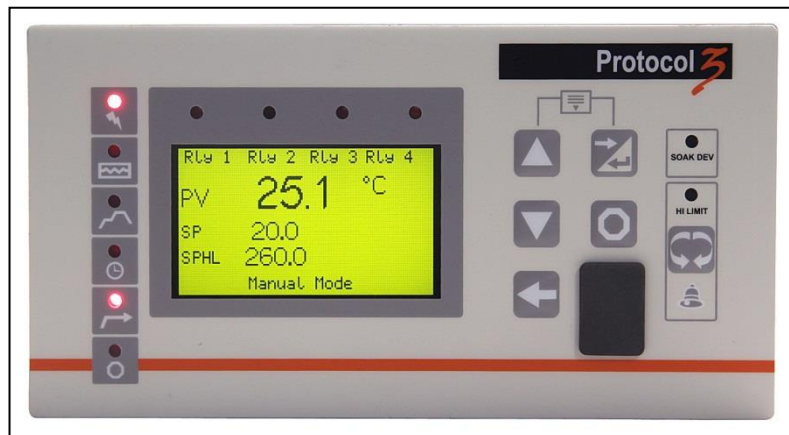

Figure 6. Protocol 3 Operator Interface.

Review the Protocol 3 Controller Owner's Manual for more information.

4. Assembly & Setup

Assembly and Setup provides directions for unpacking and installing your Despatch LBB Series oven.

4.1. Unpack & Inspect the LBB Series Oven

Remove all packing materials and thoroughly inspect the oven for any damage that might have occurred during shipment.

- Note whether the carton and plastic cover sheet inside carton are still in good condition
- Observe all outside surfaces and corners of the oven for scratches and dents
- Check oven controls and indicators for normal movement, bent shafts, cracks, chips or missing parts such as knobs and lenses
- Check the door and latch for smooth operation
- Check the packing list to ensure you received all the specified components of the oven system. The base oven includes:
 - One (1) Despatch oven
 - One (1) Instruction manual (CD)
 - Two (2) Shelves

4.1.1. If Damaged During Shipping

If damage occurred during shipping:

- Contact the shipper immediately and file a written damage claim.
- Contact Despatch Industries (**1-800-473-7373** or **1-952-469-8230** or **service@despatch.com**) to report your findings and to order replacement parts for those damaged or missing. Send a copy of your filed damage claims to Despatch industries (**Despatch Industries, 8860 207th Street, Lakeville, MN 555044, USA**).

4.2. Set-up the LBB Series Oven

4.2.1. Select Oven Location/Operating Environment

The Despatch LBB Series oven is designed to operate in an industrial setting. Despatch recommends the following environmental operating guidelines:

1. Place the oven on a flat, level solid foundation.
2. Do not expose the oven to excessive external vibration.
3. Do not remove electrical cabinet covers.
4. Where excessive particulate matter is present, such as on a construction site or coal processing, Despatch recommends periodic (usually monthly) cleaning of all electrical compartments.
5. Ensure the power supply meets Despatch specifications. If the facility power supply is not stable, Despatch recommends a line conditioner.

4.2.2. Set-up Procedure

	<p>Warning!</p> <p><i>All grounding and safety equipment must be in compliance with applicable codes, ordinances and accepted safe practices.</i></p>
---	--

	<p>Warning!</p> <p><i>Do not use the oven in wet, corrosive or explosive atmospheres unless this oven is specifically designed for a special atmosphere.</i></p>
---	---

1. Place oven on bench top or optional cabinet base.
 - a. Ensure a minimum of six (6) inches (15.3 cm) clearance in the rear of oven to provide proper ventilation. The oven may be placed next to another cabinet, or next to another oven, with three (3) inch (7.6 cm) clearance (the doors will still open).
 - b. Ensure oven is level and plumb for proper heat distribution and operation of all mechanical components.
2. Identify correct power source indicated on the specification nameplate.
3. Plug or hardwire oven directly to the electric supply.

4.2.3. Wiring & Power Connections

	<p><i>Read the Model LBB nameplate (top of oven or top of control area under the door) for proper power requirements before proceeding with wiring and power connections (Figure 7).</i></p>
---	--

	<p>Danger!</p> <p><i>All grounding and safety equipment must be in compliance with applicable codes, ordinances and accepted safe practices.</i></p>
---	---

Model LBB1-23 come equipped with an appropriate plug and cord. Models LBB1-69 and LBB2-12, -18, -27 must be hardwired to the electric supply using 10 AWG or larger wires suitable for at least 75 °C (167 °F).

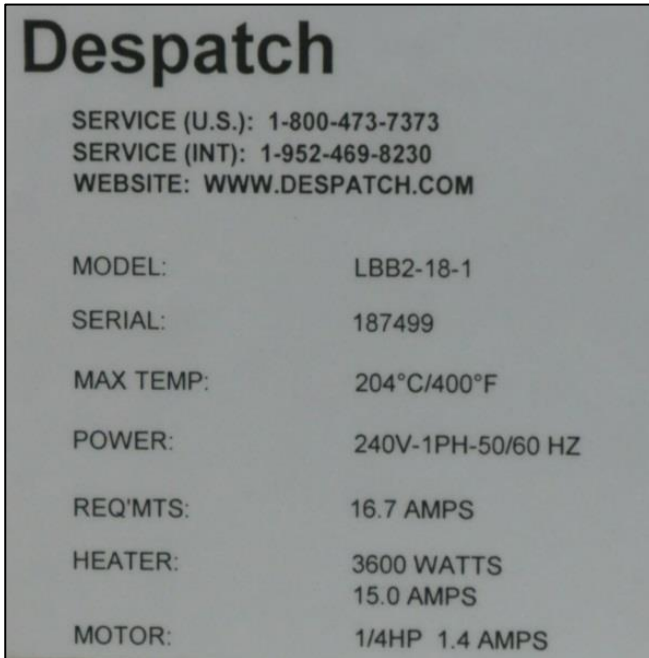

Figure 7. LBB Series Oven Name Plate Example.

To wire the LBB Series oven
(for units requiring hardwiring):

1. Remove the top cover for access to the connector block (Figure 8).



Figure 8. LBB Series Oven with Top Removed.

2. Run the wire through the rear access hole (Figure 9) and connect the appropriate wires at the connector block (Figure 10).



Figure 9. Wiring Access through Rear of Oven.

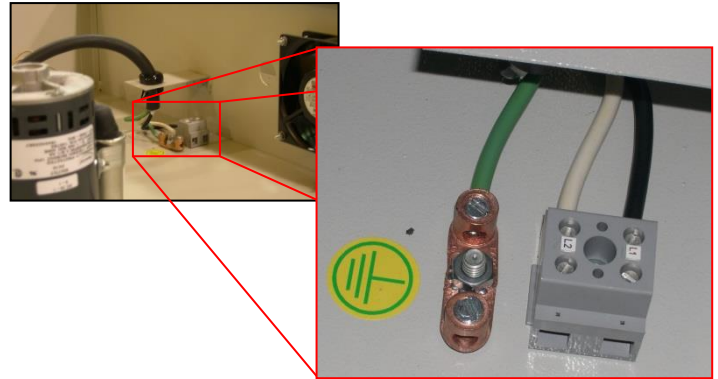





Figure 10. Close-up of Connector Block.

5. Operation

	<p><i>Users and operators of this oven must comply with operating procedures and training of operating personnel as required by the Occupational Safety and Health Act (OSHA) of 1970, Section 5 and relevant safety standards, and other safety rules and regulations of state and local governments. Refer to the relevant safety standards in OSHA and National Fire Protection Association (NFPA), Section 86 of 1990.</i></p>
---	--

	<p>Warning!</p> <p><i>Do not use the oven in wet, corrosive or explosive atmospheres unless this oven is specifically designed for a special atmosphere.</i></p>
---	---

5.1. Load Oven

	<p><i>Despatch Industries cannot be responsible for either the process or process temperature used, or for the quality of the product being processed. The purchaser and operator are responsible ensure that the product undergoing processing in a Despatch oven is adequately protected from damage.</i></p> <p><i>Carefully following the instructions in this manual will help the purchaser and operator in fulfilling that responsibility.</i></p>
---	---

	<p>Warning!</p> <p><i>Do not use corrosive liquids or flammable solvents in the oven. Do not set product or liquids on top of the oven. Liquids that may spill on the oven floor or top of oven may cause considerable damage to the oven.</i></p>
---	---

	<p>Warning!</p> <p><i>Never operate the LBB Series oven at a temperature in excess of the maximum operating temperature of 204°C (400°F).</i></p>
---	--

The two shelves are designed to be pulled out about halfway without tipping. Do not overload the shelves (Refer to Support Capacity listed in Section 1.5.3). Distribute the workload evenly so airflow is not restricted. Do not overfill your oven. The workload should not take up more than two-thirds of any dimension of the inside cavity.

For units where the controls are on the bottom, avoid spilling on the heater elements or oven floor when loading the oven. Do not place the load on the oven floor plate. Placing the load on the oven floor may cause the load to heat unevenly and the weight may cause shorting out of the heater elements. Use the shelves provided.

	<p>Caution!</p> <p><i>Always place loads on the shelves provided to avoid possible uneven heating and damage to the oven.</i></p>
---	--

5.2. Pre-Startup Checklist

	<p>Warning!</p> <p><i>Do not use flammable solvent or other flammable material in this oven. Do not process closed containers of any substance or liquid in this oven because they may explode under heat.</i></p>
---	---

- Know the system. Read this manual carefully. Make use of its instructions and explanations. Safe, continuous, satisfactory, trouble-free operation depends primarily on your degree of understanding the system and your willingness to keep all parts in proper operating condition.
- Check line voltage. Voltage must correspond to nameplate requirements of motors and controls. A wrong voltage can result in serious damage. Refer to Section 1.5.4 for more information.
- Check fresh air and exhaust openings. Do not be careless about restrictions in and around the fresh air and exhaust openings and stacks. Under no condition can they be permitted to become so filled with dirt that they reduce airflow. Refer to the Set-up instructions (4.2.2) for more information.
- Ventilation. An exhaust opening resides in the rear of the unit.

	<p><i>The exhaust vent may have to be closed to reach the maximum temperature of 204°C, especially if operating on 208 volts. The exhaust vent may need to be opened to operate properly at the lower range of the oven's design.</i></p>
---	---

- Helpful hints:
 - For drying ovens, open vent to prevent buildup of moisture

- For sample heating, close vent when no ventilation is required

5.3. Operating Procedure—Standard Control Instrument

See Protocol 3 Controller Owner's Manual for operating procedures for optional Protocol 3 control instrument.



	<p>Warning!</p> <p><i>Do not use flammable solvent or other flammable material in this oven. Do not process closed containers of any substance or liquid in this oven because they may explode under heat.</i></p>
---	---

	<p><i>For fastest oven heat-up time, close the exhaust vent. After the desired temperature is reached, adjust the vent as needed. Caution, damper may be hot.</i></p>
---	---

5.3.1. Start Oven

1. Turn **POWER ON** (Figure 11). The circulating fan will start.
2. Set exhaust vent to desired opening by adjusting the damper at the rear of the oven (Figure 12).
 - a. Adjust the vent for maximum performance at various operating temperatures.
3. Enter desired setpoint on the High Limit instrument.
 - a. Set the High Limit instrument to a temperature 10° to 14°C higher than the desired setpoint or to a temperature that should not be exceeded in the process.
 - b. If the **LOCK** on the High Limit instrument is lit, press and hold the **RESET** for four (4) seconds to enable ▲ and ▼.

	<p><i>If the High Limit instrument is exceeded, the heater shuts down. Reset the High Limit instrument by pushing RESET on the High Limit instrument.</i></p>
---	--

- c. Press . **HSP1** will light.
 - d. Use ▲ and ▼ to set the High Limit temperature.
 - e. Press **RESET** (or ) once to enter the value and return to the process variable PV mode.
4. Enter setpoint on the Control instrument.
 - a. Press  until the **SP** lights.
 - b. Use ▲ and ▼ to set the operating temperature.

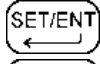
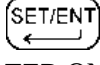
- c. Press  to enter the setpoint.
- d. Press  again to display the process temperature.
5. Turn **HEATER ON**.
 - a. When the process value on the Control instrument reaches setpoint, **OUT** cycles ON and OFF to maintain the temperature setpoint.
 - b. **OUT** lights when the control calls for heat.
6. Turn **HEATER OFF** after the heating cycle is complete.
7. Do not turn the fan OFF until the oven chamber temperature is below 100°C (212°F).

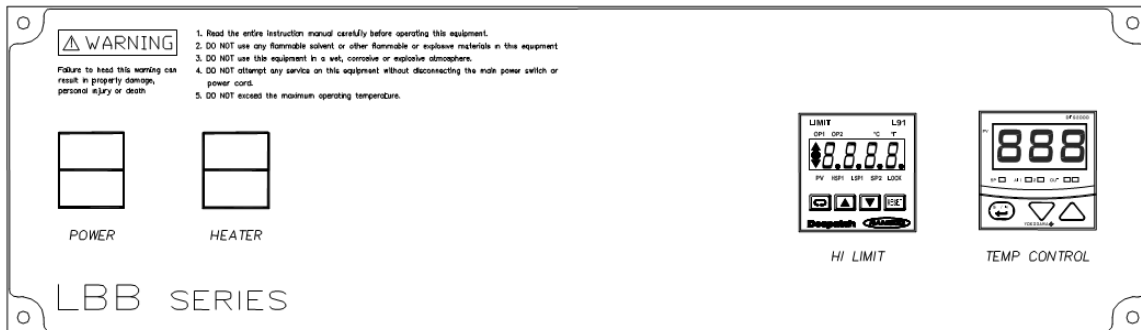



Figure 11. LBB Series Oven Control Panel.



Figure 12. Adjust Damper to Set Exhaust Vent by rotating the outer component.

	<p>Warning!</p> <p><i>Damper may be hot at elevate temperatures.</i></p>
---	---

5.4. Working with the Control Instrument

	<p>Danger!</p> <p><i>Failure to heed warnings in this instruction manual and on the oven could result in personal injury, property damage or death.</i></p>
---	--

The LBB Series oven is factory tested and the controls have been factory-set for normal operating conditions.



	<p><i>In most applications it is not necessary to alter the oven's settings, except for Setpoint.</i></p>
---	---

This section contains information for changing setpoints, programming modes, and displaying temperature, along with instructions for oven zone calibration, parameter setup mode and troubleshooting.

5.4.1. Change Setpoint

	<p>Warning!</p> <p><i>Never operate oven at a temperature in excess of the maximum operating temperature of 204°C (400°F).</i></p>
---	---

To enter Setpoint on the Control instrument:

1. Press . **SP** will light.
2. Use ▲ and ▼ to set the operating temperature.
 - a. The right decimal point LED will flash indicating the Setpoint is being changed.
 - b. The right decimal point LED stops flashing when the new value has been entered.
3. Press  to enter the Setpoint.
4. Press  again to display the process temperature.

5.4.2. Control Instrument Parameter Programming Mode

	<p>Warning!</p> <p><i>Changing program parameters alters the function of the Control. Proceed carefully and fully understand each parameter before changing that parameter.</i></p>
---	--

Control instrument parameters are set through the Operating and Set-up modes. In most applications, it is not necessary to alter the oven settings. The following instructions describe how to access, view and if desired, change the parameters. Once the Operating and Set-up modes are accessed, **SP** will start blinking on and off. Table 4 and Table 5 explain the Operating and Set-up Mode parameters.

The Control Instrument will not allow the display to be altered improperly. The Control Instrument will automatically exit the Parameter Programming mode if no keys are pressed for about two (2) minutes.

5.4.2.1. Entering Control Instrument Set-up and Configuration Mode

To enter the Operating and Set-up Mode (Figure 4):





1. Press  for three (3) seconds.
2. Press  until the desired parameter displays. See Table 4 for more information.
3. Press ▲ or ▼ to display the value.
4. Use ▲ or ▼ to move to the desired setting.
5. Press  to enter the value.
6. Press  and hold for three (3) seconds to return to the display mode.

Table 4. Control Instrument Set-up Parameters.

Code	Name	Description	Settings
CtL	Control Mode	Determines whether controller functions as a time proportional or an on/off control.	PID
At	Auto-tuning	OFF for PID tuning, ON for controller to tune process	OFF
P	Proportional Band	Expressed in degrees, value determines the band width on both sides of the setpoint within which the control provides proportional control.	4 (8 if °F)*
I	Integral Time	Expressed in seconds, value corrects for errors in actual temperature versus the setpoint	15
d	Derivative Time	Expressed in seconds, value shows the effect of the derivative time is in direct proportion to the time setting	0
Ct	Cycle Time	Expressed in seconds, value shows total time for one ON/OFF cycle of the controller output during the proportional action	1
FL	Input Filter	Expressed in seconds. Use this function when the PV may fluctuate greatly (for example, when an input signal contains noise)	0

Code	Name	Description	Settings
bS	PV Bias (Offset)	Expressed in degrees, from -199 to 999. Use this parameter to calibrate oven temperature.	0
LoC	Key Lock	Provides levels of access to the controller: <ul style="list-style-type: none"> • 0 = No key lock, full access to controller • 1 = Prevents changing of all parameters except setpoint • 2 = Prevents all parameters from being changed including the setpoint • -1 = Set to enter the Set-up parameter setting display. 	1
nr	Manual Reset	Only when I & d are OFF . Expressed in percent. Controller outputs this value when process variable equals setpoint, but only if I = 0 .	N/A
Hys	Hysteresis	Only when CtL is OFF , change CtL to PID) Expressed in degrees. When CtL = OFF , this value determines the change in temperature needed to turn controller output from full OFF to full ON .	N/A

*If **P** is not displayed the Control Mode (**CtL**) must be first set to **PID**.

5.4.2.2. Control Instrument Operating Mode Notes



- The controller is factory set to **LoC=1** (allowing only the setpoint to be changed). This setting prevents inadvertent changing of control parameters.
- If necessary to alter control parameters, change the **LoC=1** to **LoC=0**. See Section 5.4.2.1 for more information.
- When **LoC** = **-1**, parameters are displayed in the order shown in the Set-Up Parameters table (Table 5).
- **Note:** If unable to change setup parameters:
 - Change the **LoC** = **0**
 - Press the  until **LoC** appears again
 - Change **LoC** = **-1**
 - Press the 











Table 5. Control Instrument Configuration Parameters.

Code	Name	Description	Settings
In	Input Type	Set for type of input and whether PV is in °C or °F	5 (35 if °F)
SPH	Setpoint High	The maximum setpoint limit for oven. The user cannot set the setpoint above the maximum setpoint.	204 (400 if °F)
SPL	Setpoint Low	The minimum setpoint limit of oven. The user cannot change the setpoint below this lower setpoint limit.	0 (32 if °F)
SC	Super Function	Despatch recommends leaving the SC feature OFF	OFF
dr	Direct/Reverse Action	Direct/Reverse action. This value is set for 0 (reverse action).	0
dSP	PV/SP Display	Priority of PV/SP display. This parameter either displays the PV (process variable) or SP (setpoint). <ul style="list-style-type: none"> • 0 = process variable • 1 = setpoint 	0

5.4.3. Change Control Instrument Display from Centigrade to Fahrenheit

	<p>Warning!</p> <p><i>Program parameter changes will alter the function of the Control instrument. Proceed carefully and fully understand each parameter before changing that parameter.</i></p>
---	---

Configure the Control instrument for either °C or °F. Use the following steps to change control from displaying °C to °F:

1. Press and hold  for three (3) seconds.
 - a. **CtL** displays.
 - b. **SP** will flash indicating the Control Instrument has entered Operating Parameter mode.
2. Press  until **LoC** displays.
3. Press **▲** or **▼** to enter parameter.
4. Press the **▼** to set the value to **-1**.
 - a. **SP** will flash rapidly indicating the Control Instrument has entered Set-Up Parameter mode.
5. Press  to enter the value.
 - a. **In** displays.
 - b. Press the **▲** or **▼** to enter the parameter.
 - c. **Note:** If unable to change setup parameters, follow this procedure:
 - i. Press and hold  for three (3) seconds to return to the operation mode.
 - ii. Change the **LoC** to 0.
 - iii. Press  until **LoC** displays.
 - iv. Change **LoC** to **-1**.
 - v. Press .
6. Enter the value **35**.
 - a. The right decimal point LED will flash indicating that the setpoint is being changed.
 - b. The decimal will stop flashing when the new value has been entered.
 - c. Press  to enter the value.
7. Press  until **SPH** displays.
 - a. Press **▲** or **▼** to enter the desired parameter.
8. Enter a value of **400**.
 - a. Press  to enter the value.
9. Repeat steps 7-8 for **SPL**.
10. Enter a value of **32**.
11. Press and hold the  for three (3) seconds to return to the operation mode.
 - a. The control now reads in degrees Fahrenheit.
 - b. Enter the desired setpoint.
12. Re-enter parameters from table 4 (note: this action defaults settings from lower level to high level)

Refer to Table 5 to change tuning parameters, if necessary.

	To change from Fahrenheit to Centigrade, repeat the steps in Section 5.4.3 using $\ln = 5$, $\text{SPH} = 204$, $\text{SPL} = 0$
---	--

5.4.4. Oven Zone Calibration

The Control instrument has been factory-tested and calibrated. Under normal operating conditions, recalibration should not be necessary. However, to recalibrate the Control Instrument for a specific operating condition, follow the instructions below.

	Warning! Changing program parameters alters the function of the Control. Proceed carefully and fully understand each parameter before changing that parameter.
---	---

1. Required Equipment: Temperature measuring device with a compatible temperature sensor.
2. Verify that **bS** (PV Bias) programmed in the Control instrument is set to 0. For more information on programming parameters refer to Section 5.4.2.1.
3. Locate the temperature sensor of the temperature measuring device at the center of the chamber.

	Load the chamber with a standard amount of product to simulate a specific operation condition.
---	---

4. Operate the oven until it reaches the desired operating temperature and the Control instrument is regulating.
 - a. It will take several minutes for the unit to stabilize at the controlled temperature.
 - b. Allow at least 30 minutes of operation at the stabilized temperature before proceeding.
5. Subtract the average controlled temperature (value appearing on the Control instrument display) from the actual oven temperature (value appearing on the temperature measuring device display).
 - a. Note that the Control instrument and the temperature sensing device must be in the same scale ($^{\circ}\text{C}$ or $^{\circ}\text{F}$).

$$\text{Actual Oven Temperature} - \text{Controlled Oven Temperature} = \text{Calculated Value}$$

5.4.5. Set the High Limit

	<p>Danger!</p> <p><i>Failure to heed warnings in this instruction manual and on the oven could result in personal injury, property damage or death.</i></p>
---	--



The oven has been factory-tested with the High Limit instrument factory-preset for normal operating conditions. In most applications, it will not be necessary to alter the oven's settings, except for the Setpoint. This section contains information and reference material to change Setpoint, access the Set-up mode and change display between °C and °F.

The High Limit instrument was carefully programmed at the factory using the Operating and Set-up mode. The parameters that may be accessed include; display functions, and thermocouple selection.

5.4.5.1. Change the High Limit Instrument Setpoint

	<p>Warning!</p> <p><i>Never operate oven at a temperature in excess of the maximum operating temperature of 204°C (400°F).</i></p>
--	---

Enter setpoint on the High Limit instrument. Set High Limit instrument to a temperature 10°C to 14°C higher than the setpoint or to a temperature that should not be exceeded in the process.



1. If **LOCK** on the High Limit instrument is lit, press and hold **RESET** for four (4) seconds to enable ▲ and ▼.
2. Press , HSP1 will light.
3. Use ▲ and ▼ to set High Limit temperature.
4. Press **RESET** or  once to return (also enters the value) to the process variable PV mode.
5. If the High Limit instrument is exceeded the heater will shut down.
6. Reset the High Limit instrument by pushing **RESET** on the High Limit instrument.

5.4.6. High Limit Instrument Parameter Setup Mode

	<p>Warning!</p> <p><i>Changing program parameters alters the function of the High Limit. Proceed carefully and fully understand each parameter before changing that parameter.</i></p>
---	---

Set High Limit instrument parameters using the Operating and Set-up modes (Section 5.4.2.1). See section 5.4.4. to calibrate High Limit, only use SHif parameter. In most applications, it is not necessary to alter the oven settings. The following instructions describe how to access, view and, if desired, change the parameters.

If the **LOCK** on the High Limit instrument is lit, press and hold **RESET** for four (4) seconds to enable **▲** and **▼**. The High Limit instrument will automatically exit Setup mode if no keys are pressed for about two (2) minutes.

1. Press and hold  for four (4) seconds to enter Setup mode.
2. Press  until desired parameter displays. See the Setup Parameter Table for more information.
 - a. The display will alternate between the parameter name and value.
 - b. Use **▲** or **▼** to move to the desired setting.
 - c. Press  to the value and advance to the next parameter.
3. To leave setup parameters press **RESET**. The High Limit instrument automatically exits Setup mode if no keys are pressed for about two (2) minutes.

5.4.7. High Limit Instrument Setup Parameters

Table 6 explains the High Limit instrument setup parameters.



	<i>When changing between centigrade and Fahrenheit, the setup parameters Filt, o1.Hy, HSP.L and HSP.H settings convert automatically.</i>
---	--

Table 6. High Limit instrument Setup Parameters.



Code	Name	Description	Settings
inPt	Input type	Select thermocouple type. LBB Series ovens use type J thermocouples	J_tC
unit	Process unit.	Select between °C and °F for reading process temperature	°C (or °F)
rESo	Display resolution.	Select location of decimal point on process-related parameters	No.dP
SHif	PV shift value (offset).	Moves the display temperature to the oven temperature	0
Filt	PV filter.	If the process value is unstable to read, increasing this value steadies the input signal.	0
out1	Output 1 function.	Function of the output. Must be set to Hi. for High Limit control.	Hi.
o1.Hy	Output 1 hysteresis value.	Amount of degrees the temperature must be below the setpoint temperature before the High Limit can be reset	2.0

HSP.L	Lower limit of HSP1.	Minimum temperature setting for the High Limit	0 (32 if °F)
Code	Name	Description	Settings
HSP.H	Upper limit of HSP1.	Maximum temperature setting for the High Limit	204 (400 if °F)
out2	Second output	Despatch does not use this function	None
diSP	Normal display format.	Used to select the display in normal condition: <ul style="list-style-type: none"> • PV = Process Value • SP! = High Limit Setpoint • SAFE = The word "safe" in normal condition 	PV
PuHi	Process value high	Read-Only Data: Maximum process value since last UNLOCK operation.	None
PuLo	Process value low	Read-Only Data: Minimum process value since last UNLOCK operation.	None
t.Abn	Abnormal time	Total accumulated minutes of abnormal conditions since last UNLOCK operation.	None

5.4.8. Change High Limit instrument Display from Centigrade to Fahrenheit

	<p>Warning!</p> <p><i>Changing program parameters alters the function of the Control. Proceed carefully and fully understand each parameter before changing that parameter.</i></p>
--	--

Configure the High Limit instrument for either °C or °F. Use the following steps to change High Limit instrument from displaying °C to °F (and for changing back):

1. If **LOCK** on the High Limit instrument is lit, press **RESET** and hold for four (4) seconds to enable ▲ and ▼.
2. Press and hold  for four (4) seconds to enter Setup mode.
3. Press  until **unit** displays.
4. Display will alternate between parameters and settings
5. Use ▲ or ▼ to move to the desired setting.
6. Press  to enter the value and advance to the next parameter.
7. Press **RESET** to return the High Limit instrument to normal mode.
8. The High Limit instrument has been changed, enter the desired setpoint.
9. Lock turns back on automatically after approximately sixty (60) seconds.

5.5. Working with Optional Protocol 3 Controller Operating Modes

Refer to the Protocol 3 Controller Owner's Manual for specifics on working with the Protocol 3 controller.

6. Maintenance

	<p>Danger!</p> <p><i>Failure to heed warnings in this instruction manual and on the oven could result in personal injury, property damage or death.</i></p>
---	--

	<p>Danger!</p> <p><i>Do not attempt any service on this oven before opening the main power disconnect switch.</i></p>
---	--

	<p>Warning!</p> <p><i>Do not place this oven in an environment harmful to electrical components.</i></p> <p><i>Placing this oven in an environment detrimental to electrical components (for example, environments where carbon fibers, coal dust or similar contaminants may be present) may result in component failure.</i></p> <p><i>Do not use liquids in the oven. Do not set product or liquids on top of the oven. Liquids that may spill on the oven floor or top of oven may cause considerable damage to the oven.</i></p> <p><i>Contact Despatch for options available to help prevent such failures.</i></p>
---	--

6.1. Checklist

- Keep equipment clean. Gradual dirt accumulation retards airflow. A dirty oven can result in unsatisfactory operation such as unbalanced temperature in the work chamber, reduced heating capacity, reduced production, overheated components. Keep the walls, floor and ceiling of the oven work chamber free of dirt and dust. Floating dust or accumulated dirt may produce unsatisfactory work results. Keep all equipment accessible. Do not permit other materials to be stored or piled against it.
- Protect controls against excessive heat—particularly controls, motors or other equipment containing electronic components. Temperatures greater than 51.5°C (125°F) should be avoided.
- Establish maintenance and checkup schedules. Do this promptly and follow the schedules

faithfully. Careful operation and maintenance will be more than paid for in continuous, safe and economical operation.

- Maintain equipment in good repair. Make repairs immediately. Delays may be costly in added expense for labor and materials and in prolonged shut down.
- Practice safety. Make it a prime policy to know what you are doing before you do it. Make **caution, patience, and good judgment** the safety watchwords for the operation of your oven.

6.2. Lubrication

Fan motor bearings are permanently lubricated. All door latches, hinges, door operating mechanisms, bearing or wear surfaces should be lubricated to ensure easy operation.

6.3. Cleaning and Decontamination

6.3.1. Cleaning the LBB Series Oven

	<p>Warning!</p> <p><i>Do not clean oven without first disconnecting power.</i></p>
--	---

For best product results, clean the oven monthly. To clean the oven:

1. Wipe all surfaces with a moistened towel or use a neutral cleaning agent.
2. Use a moistened towel to remove cleaning agents when finished.
3. Dry oven completely before turning it on again.

Clean stainless steel surfaces quarterly. To clean stainless steel surfaces:

1. Wash steel surface using a polyurethane cloth or sponge with clean water and liquid detergent.

<p>Notice</p>	<p><i>Clean quickly for maximum surface protection.</i></p> <p><i>Using water that contains chlorine or hydrochloric acid to clean may damage the oven. Choose a neutral cleaning agent instead.</i></p>
----------------------	--

6.3.2. Decontaminating the LBB Series Oven

	<p>Warning!</p> <p><i>Do not decontaminate oven without first disconnecting power. Ensure adequate personal safety while decontaminating oven.</i></p>
---	---

<p>Notice</p>	<p><i>Before using any cleaning or decontamination method except those recommended by the manufacturer, users should check with the manufacturer that the proposed method will not damage the equipment.</i></p>
---------------	--

For best results, decontaminate the work zone daily.

1. Wipe all work surfaces with an appropriate disinfectant.
2. Use a neutral cleaning agent. Do not use acidic or chlorine cleaning detergents as they may damage or corrode the oven.

	<p><i>If necessary, remove highly contaminated inner chamber parts for cleaning or exchange.</i></p>
--	--

	<p>Danger!</p> <p><i>Explosive gases may form during decontamination. Dry and ventilate oven before start-up to avoid explosions.</i></p>
---	--

6.4. Routine Tests

	<p>Danger!</p> <p><i>Failure to heed warnings in this instruction manual and on the oven could result in personal injury, property damage or death.</i></p>
---	--

Test LBB Series oven functions regularly and carefully for best performance. Safety of personnel and maintenance of your equipment may depend on the proper operation of any of the temperature control functions.

6.4.1. Test Control Instrument

Test the Control instrument every 40 hours:

- Check that the Control instrument **OUT** LED is cycling ON and OFF
- Verify that the heater works

6.4.2. Test High Limit Instrument

Test the High Limit instrument every 40 hours. With the oven operating at a set temperature, set High Limit instrument down to the setpoint operating temperature:

- The High Limit instrument is tripped when **OP1** lights
- Push **RESET** after adjusting the High Limit instrument back to a higher setting, or by letting the oven temperature drop a few degrees based on the hysteresis value of the High Limit instrument

6.5. Replacement Parts

	<p><i>Danger!</i></p> <p><i>Do not attempt any service on this oven before opening the main power disconnect switch or removing all power from the oven.</i></p>
---	--

To order or return parts, contact Despatch Service and Technical Support. When returning parts, a Despatch representative will provide an MRA (Material Return Authorization) number. Attach the MRA number to the returned part for identification. When ordering parts, expedite the process by having the model number, serial number and part number on hand.

Global Headquarters	Contact	Service & Technical Support
Despatch Industries 8860 207th Street Lakeville, MN 55044 USA	International/Main: 1-952-469-5424 US toll free: 1-800-726-0110 Fax: 1-952-469-4513 info@despatch.com www.despatch.com	Service: 1-952-469-8230 US toll free: 1-800-473-7373 Fax: 1- 952-469-8193 Service @despatch.com Parts@itweae.com

6.5.1. Replace the Control Instrument

	<p>Danger!</p> <p><i>Do not attempt any service on this oven before opening the main power disconnect switch or removing all power from the oven.</i></p>
---	--

Tools needed:

- One-quarter (1/4) inch socket set
- P1 Phillips Tip Screwdriver
- T20 Torx bit driver

1. Disconnect power.
2. Remove four screws from the face of the control panel (Figure 13).



Figure 13. Remove Control Panel to Access Control Instrument (using T20 Torx bit driver).

- Slide the panel forward (Figure 14). Support the panel while working by wedging a flat surface between the oven door and oven ceiling.



Figure 14. Providing easy access to the Control instrument.

- Remove wires from the old control instrument (using P1 Phillips screwdriver), carefully noting which wires connect to which terminals (Figure 15).

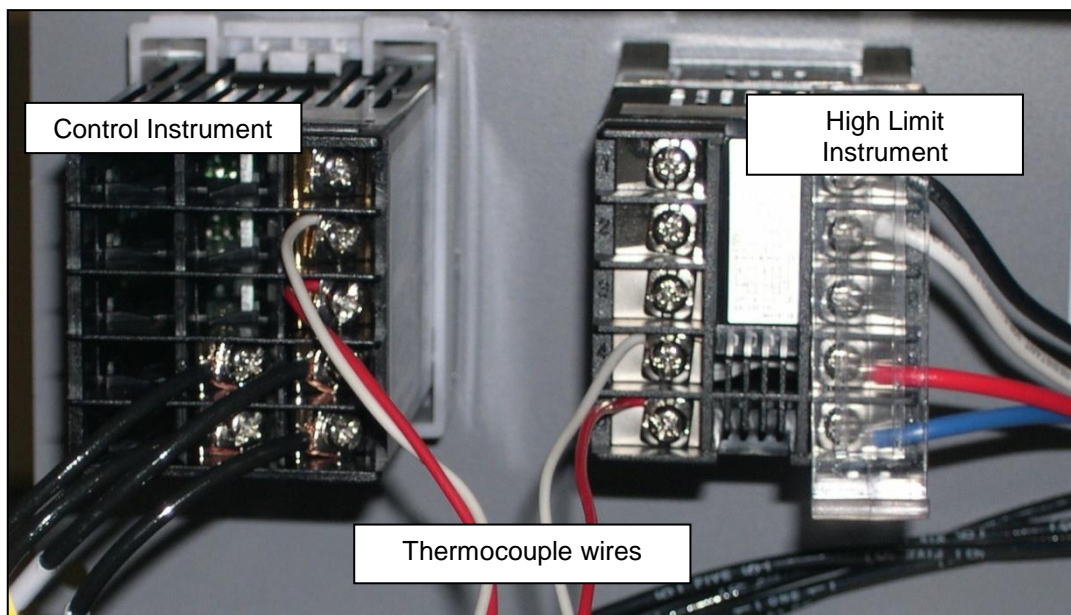

Figure 15. Remove old Control and High Limit Instruments and Wiring (Rear View).

5. Move the Control instrument mounting bracket back and off (Figure 16).

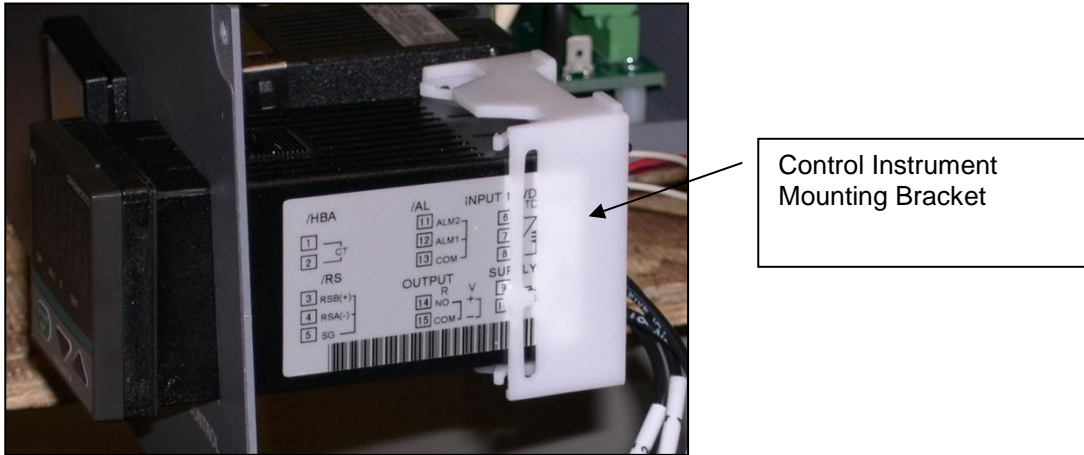

Figure 16. Prepare to remove control instrument by removing the mounting bracket.

6. Remove old Control instrument from the panel.
7. Install new Control instrument into the control panel.
8. Secure instrument mounting bracket.
9. Reattach wires to the new Control instrument. Double-check that the wires are connected correctly. See Figure 17 for correct Control instrument connections.
10. Reinstall control panel.

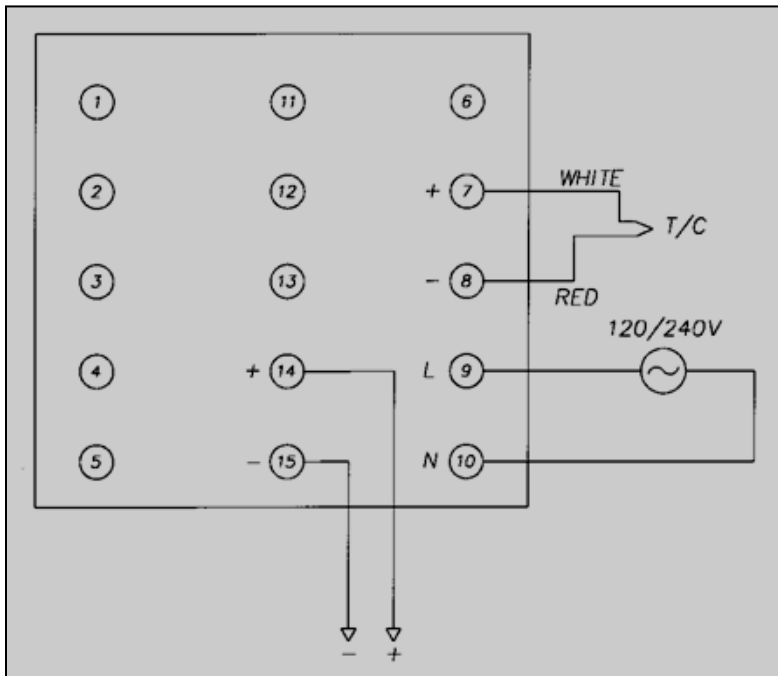



Figure 17. Connections to Control Instrument.

6.5.2. Replace High Limit Instrument

	<p>Danger!</p> <p><i>Do not attempt any service on this oven before opening the main power disconnect switch or removing all power from the oven.</i></p>
---	--

Tools needed:

- One-quarter (1/4) inch socket set
- Screwdriver
- T20 Torx bit driver

1. Disconnect power.
2. Remove four screws from the face of the control panel (Figure 13).
3. Slide the panel forward (Figure 14).
4. Remove wires from the old High Limit instrument, carefully noting which wires connect to which terminals (Figure 15).
5. Disconnect High Limit instrument connector from circuit board (Figure 18).

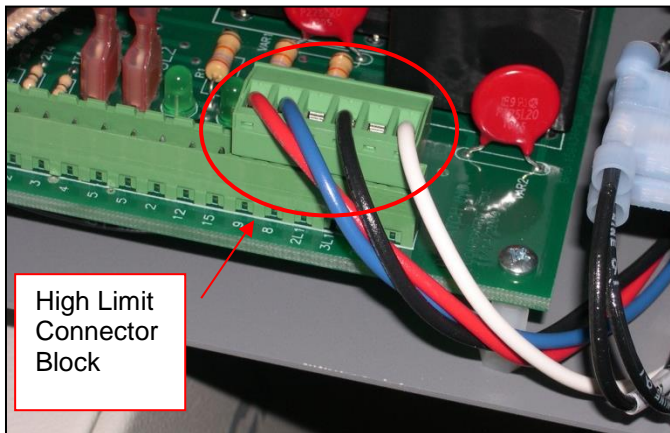

Figure 18. High Limit Connector Block on Control Board.

6. Disconnect the thermocouple wires (Figure 15).
7. Press and hold down the tabs holding the High Limit instrument to the control panel and slide it out (Figure 19).

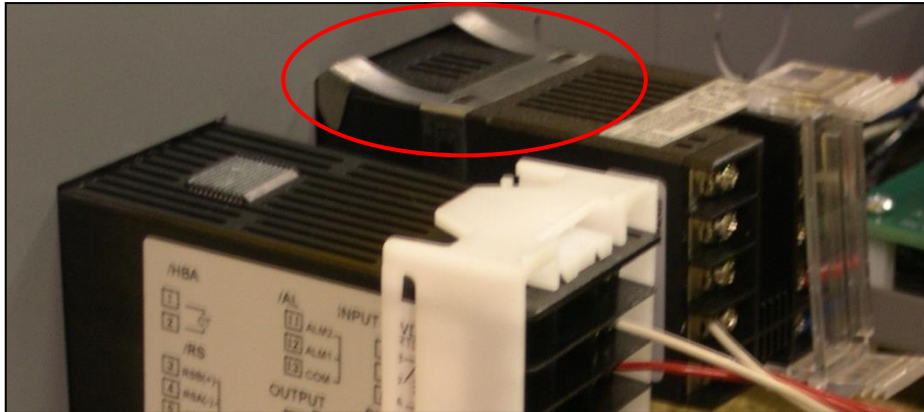

Figure 19. Press and Hold Tabs to Remove High Limit Instrument.

8. Install new High Limit instrument into the control panel.
9. Replace mounting bracket.
10. Connect High Limit instrument connector plug to the circuit board (Figure 18).
11. Reattach thermocouple wires. Make sure that the wires are connected correctly. (Figure 15).
See Figure 20 for correct High Limit instrument connections.
12. Reinstall control panel.

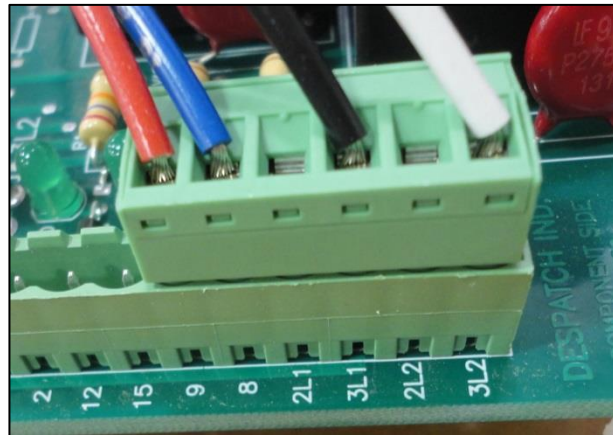
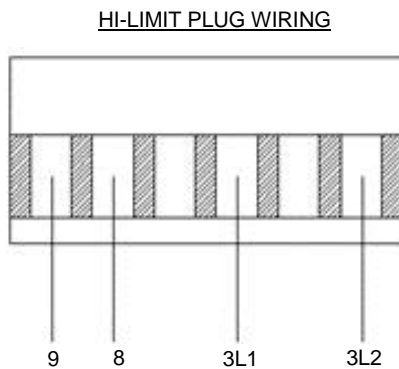



Figure 20. Connections to High Limit Instrument.

6.5.3. Replace (Optional) Protocol 3 Controller

Refer to the Protocol 3 Owner's Manual for instructions on replacing the Protocol 3 Controller.

6.5.4. Replace Heater Unit

	<p>Danger!</p> <p><i>Do not attempt any service on this oven before opening the main power disconnect switch or removing all power from the oven.</i></p>
---	--

Tools needed:

- Thin open end wrench
- One-quarter (1/4) inch socket set
- T15 Torx bit driver

1. Disconnect power.
2. Remove shelves (Figure 21).
3. Remove left and right side ducts
 - a. Remove screws from each duct.
 - b. Remove duct from oven.
4. Remove heater cover (located on the top or bottom of the oven, depending on model).
 - a. Remove screws from the heater cover.
 - b. Remove heater cover from the oven.
5. Disconnect heater leads from heater element with wrench, carefully noting which wires connect to which terminals (Figure 22).
6. Remove old heater (Figure 23).
 - a. Remove screws holding the heater frame to the oven body.
 - b. Remove heater and discard.
7. Install new heater
 - a. Secure new heater frame with screws.
 - b. Attach heater leads to appropriate terminals with care to not damage insulator. Note the orientation of terminals to avoid short circuits (Figure 22)
8. Reinstall heater cover.
9. Reinstall side ducts.
10. Reinstall shelves.



Figure 21. Remove Screws to Remove Each Duct (using T15 Torx bit driver).

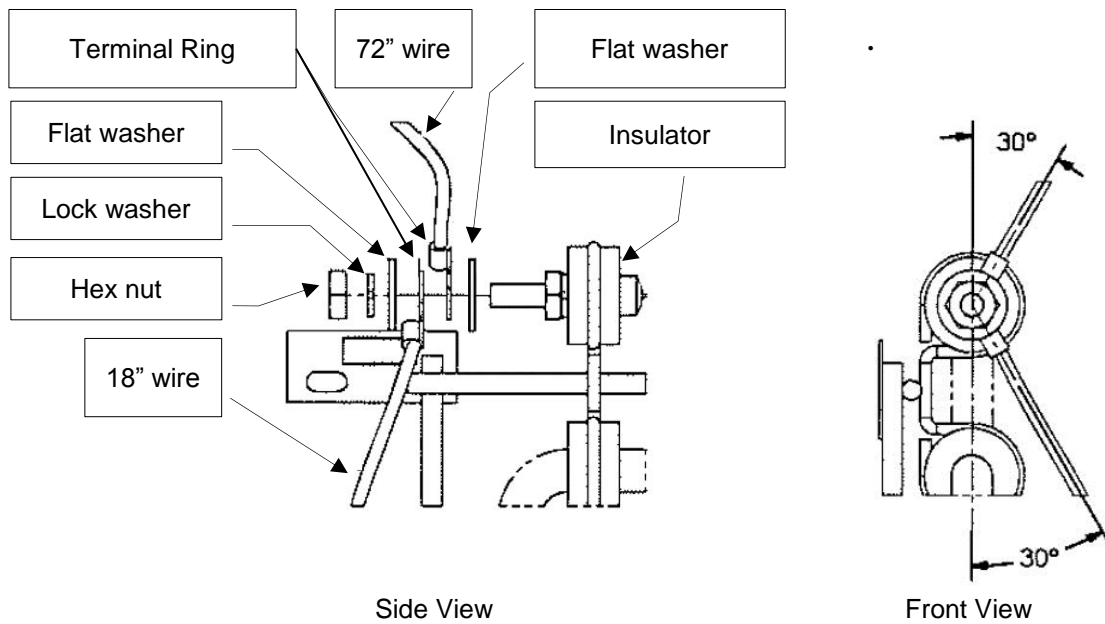

Install terminals as shown to prevent possible electrical shorts and/or stress on terminals. Angle tolerance: +/- 15°.

Figure 22. Heater element connections.

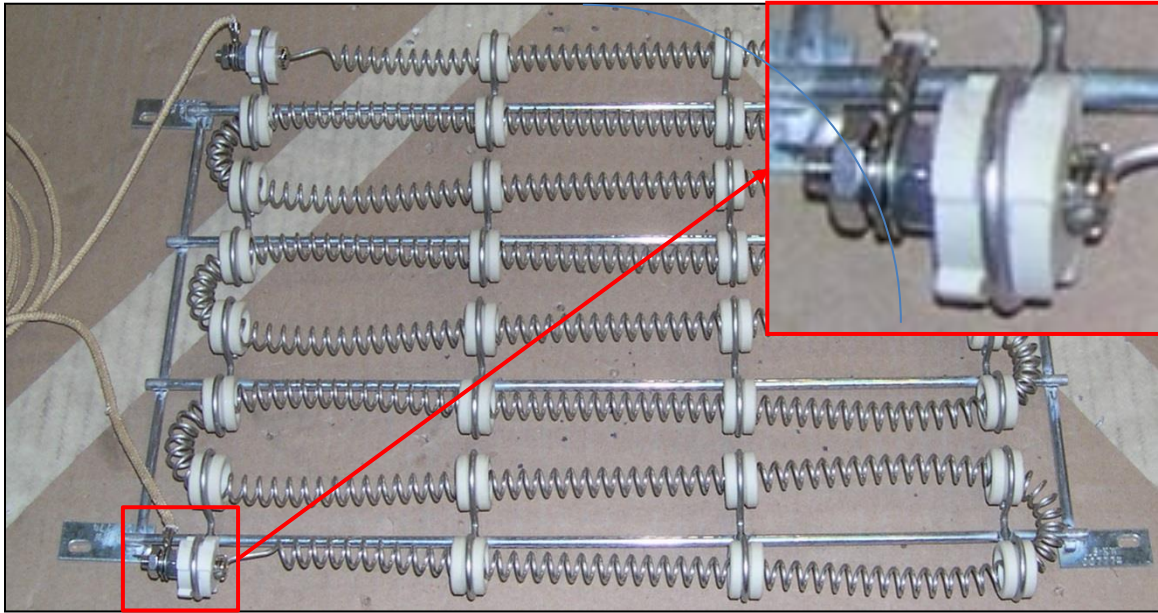



Figure 23. Typical Heating Element (Inset connections see Figure 22) .

6.5.5. Replace Fan Motor

	<p>Danger!</p> <p><i>Do not attempt any service on this oven before opening the main power disconnect switch or removing all power from the oven.</i></p>
---	--

Tools needed:

- One-quarter (1/4) inch socket set
- 5/32 inch Allen wrench
- Screwdriver
- T15, T20 and T30 Torx bit drivers

1. Disconnect power.
2. Remove shelves (Figure 21).
3. Remove left and right side ducts
 - a. Remove screws from each duct.
 - b. Remove duct from oven.
4. Remove heater cover (located on the top or bottom of the oven, depending on model).
 - a. Remove screws from the heater cover.
 - b. Remove heater cover from the oven.
5. Loosen setscrews (2) on fan wheel in middle of oven top. Access the fan wheel through the heater opening or by disconnecting and removing the heater assembly. Refer to Section 6.5.4 for information on removing the heater unit.
6. Remove top cover to reveal fan motor (Figure 24).

7. Remove fan motor.
 - a. Disconnect motor leads from circuit board.
 - b. Unscrew screws (4) holding motor mounts to body (T30 Torx bit driver).
 - c. Lift fan motor from oven body.
8. After running at temperature, the fan wheel may stick to the shaft. Separating the fan wheel from the fan motor shaft may require force. Use a drift or bass mallet as necessary to drive out the shaft (Figure 25).
9. Take motor mount off old motor.
10. Put motor mount onto new motor (T20 Torx bit driver).
11. Replace fan motor.
 - a. Reattach motor to oven body.
 - b. Reattach motor lead plug to circuit board.
12. Replace top cover.
13. Put fan wheel onto shaft from inside of oven.
14. Adjust fan wheel for 3/16-inch clearance between wheel and inlet ring.
15. Tighten setscrews on the fan wheel.
16. Check that setscrews hit the flats machined into the motor shaft.
17. Reinstall heater pan assembly if removed. Refer to Section 6.5.4 for information on removing the heater unit.
18. Reinstall heater cover.
19. Reinstall side ducts.
20. Reinstall shelves.

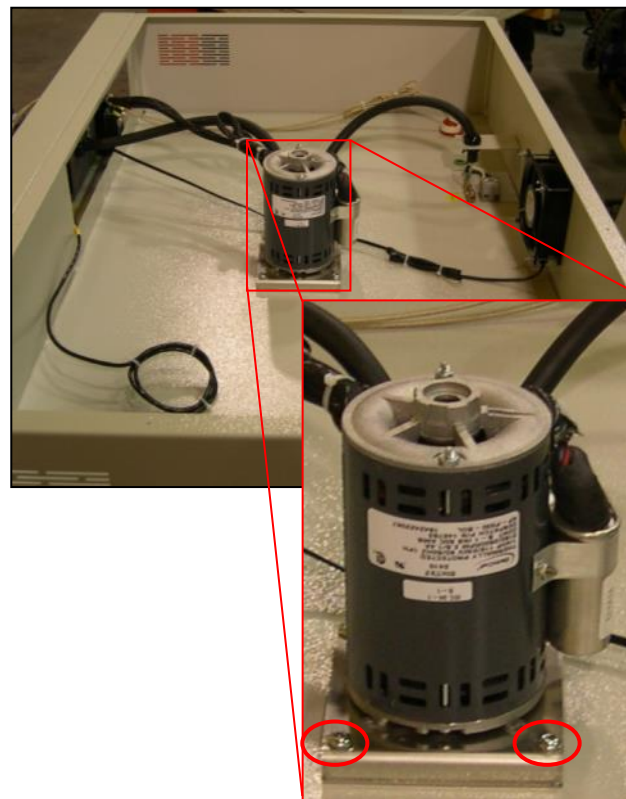

Figure 24. Fan Motor Location.

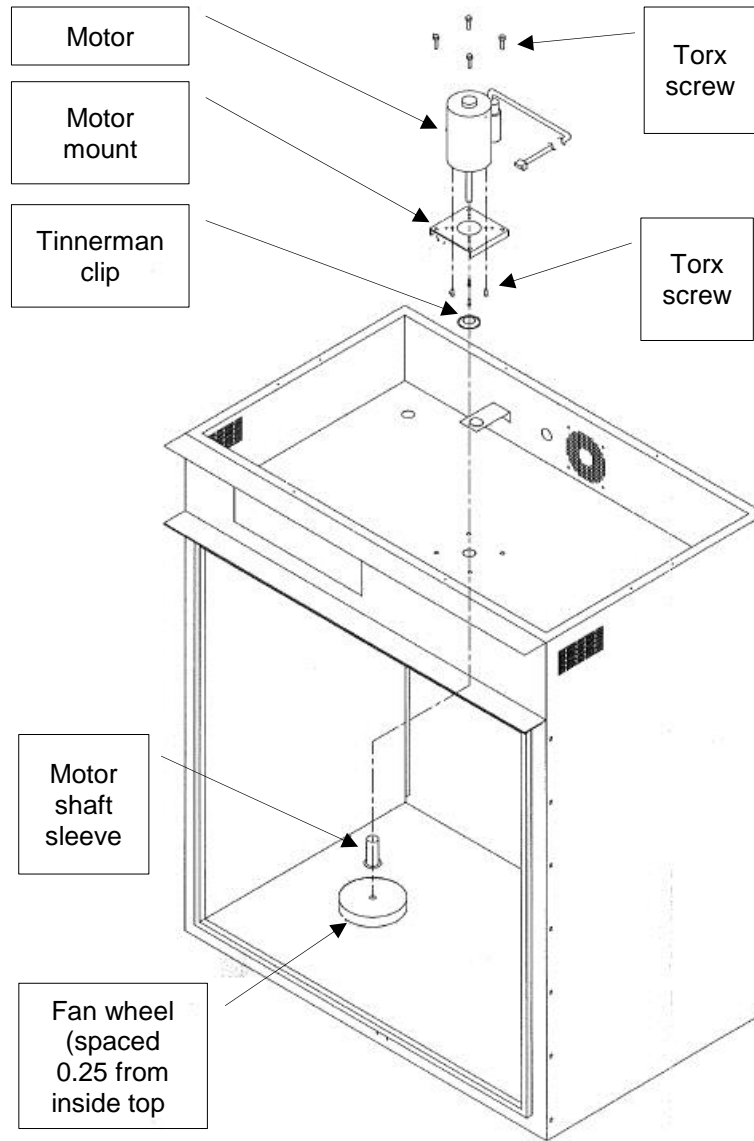

Figure 25. Separate fan wheel from fan motor shaft.

7. Troubleshooting

Table 7. Common Technical Issues and Remedies.

Technical Issue	Probably Cause	Suggested Remedy/Next Step
Failure to heat or only heats up to 30–50 °C	No power	Check power source and/or oven and wall fuses.
	Burned out heater(s)	Replace element (see Warranty statement, Section 8).
	Control Instrument malfunction	Check control parameters. Replace controller if OUT LED on controller does not turn on. See section 7.1 and 7.2
	Loose wire connections	Disconnect power and check connections behind control panel.
Slow heat up	Improperly loaded workload	Reduce load or redistribute load in chamber.
	Low line voltage	Supply sufficient power and proper connections. Check for circuit overload.
	1 or 2 heating elements burned out	Check heater amperage on the nameplate. Replace burned out element (see Warranty statement, Section 8).
	Vent is wide open.	Close vent.
	Fan motor failure	Replace fan motor.
Frequent heater element burnout	Harmful fumes generated by load	Increase vent opening or discontinue process.
	Spillage or splattering of material on heater elements	Disconnect power and clean oven chamber and elements.
	Overheating oven	Check the Control and High Limit instruments.
	Fan motor failure	Replace fan motor.
Erratic temperature	Control instrument malfunction	Check control parameters before replacing the Control instrument.
Inaccurate temperature	Control instrument miscalibration	Check control parameters. Recalibrate Control instrument.
Excess surface or door temperature	Door seal deterioration	Replace door seal.
	Door closed into top or bottom latch only	See specific difficulty below for this problem.
Improper airflow	Fan motor failure	Replace fan motor.
	Unbalanced fan wheel	Reposition fan wheel within 3/10" from top of housing. Replace fan wheel.
Excessive vibration	Dirty fan wheel	Clean fan.
	Unbalanced fan wheel	Replace fan wheel.
Grinding noise	Fan wheel has shifted or fallen.	Inspect the wheel. Reposition fan wheel within 0.25" from top of housing.

Technical Issue	Probably Cause	Suggested Remedy/Next Step
	Debris has fallen into fan through shaft collar.	Inspect the wheel for damage. Remove debris.
Oven will not control at Setpoint	High Limit instrument set too low	Set the High Limit higher.
	Control instrument malfunction	Check control parameters before replacing Control instrument.
	Air friction of recirculation fan	Open exhaust air vent. Unit will not control at minimum operating temperature with vent(s) closed.
Heater does not shut down until temp. reaches the High Limit setting	Control instrument malfunction	Verify control parameters. Replace control instrument if no output exists.
	SSR Relay malfunction	Replace relay if Control output exists.
Door closes into top or bottom latch only	Uneven latch tension adjustment	Ensure that latch strike is contacting center of latch. Adjust mounting angle as required. Adjust door for even top and bottom latch tension by turning screws on ends of latch. Clockwise increases tension on latch. Counterclockwise decreases tension.
Door will not stay closed	Inadequate latch tension	Ensure that latch strike is contacting center of latch. Adjust mounting angle to center as required. Increase latch tension by turning screws on end of latch clockwise. Adjust in even increments on all four screws to keep door pull even.



Like any equipment operating over long periods of time, technical issues may arise. Table 7 lists the common technical issues, their causes and remedies.

7.1. DES2000 Control Parameters Check

- a. If oven is not heating, first check the OUT LED. The LED should be ON for the oven to heat up. If LED is not on or blinking, you will need to verify the parameters.

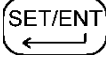
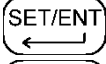
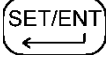
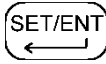

- b. Press  key for three (3) seconds.

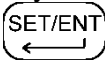
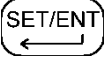
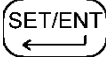
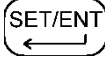
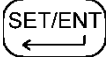
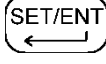
- c. The CtL parameter should be displayed. Press one of the arrow keys once and PID should be displayed, if it reads anything else, then it needs to be changed to PID.
- d. If the value does not change when pressing the arrow key, then the parameters are locked.
- e. Press and release the  key several times until LOC is displayed. Press the down arrow keys and change the parameter to 0 (zero).
- f. Press the  key several times to enter the value and return to LOC.
- g. Press the  key once so CtL is displayed again. Press one of the arrow keys until PID is displayed.
- h. Once the parameter PID is displayed, Press the  key several times to go back to CtL.
- i. Press the  key once to go to the next parameter. See Operating and Setup Parameter Table listed below. The parameters are listed in order as they appear on the control.
- j. If the P is not displayed, the Control Mode (CtL) must be first set to PID.
- k. Once you have verified each of the parameters, go to the LOC parameter and change the value to 1 (one) to lock the parameters, but still allows the set point to be changed.
- l. Press the  key once to enter the value.
- m. Press and hold the  key for three (3) seconds until the temperature (PV) is displayed.
- n. If the PV reading is not the correct temperature, re-enter the parameter mode by Pressing  key for three (3) seconds.
- o. Press and release the  key several times until LOC is displayed.
- p. If the parameter is not already 0 (zero), press the down arrow keys and change it to 0 and then Press the  key once.
- q. Press the down arrow keys and change the parameter to -1 (minus one).
- r. Press the  key once so In is displayed. Press one of the arrow keys once and 5 should be displayed for Centigrade or 35 for Fahrenheit. To change from C to F or F to C, please refer to the DES2000 controller manual.
- s. Press  key for three (3) seconds until the temperature (PV) is displayed.
- t. If you changed the In parameter, you will need to go back to Step 1 to verify all the parameters again.

Operating Parameter Outline

Code	Name	Settings
CtL	Control Mode	PID
At	Auto-tuning	OFF
P *	Proportional Band	5 **
I	Integral Time	15
d	Derivative Time	OFF
Ct	Cycle Time	1
FL	Input Filter	2
bS	PV Bias (Offset)	0
LoC	Key Lock	0

* If P is not displayed the CtL must be first set to PID.
** For F change to value 13.

7.2. Hi Limit L91 Hi-Limit Reset

- a. If the DES2000 Output LED is ON and the oven is still not heating, is the OP1 LED ON?. If it is, then the hi-limit is tripped and needs to be reset or the parameters need to be verified.



- b. Press RESET key for several seconds until the LOCK LED goes out.
- c. If the OP1 LED is still on, press  key for several seconds to enter the parameter mode.
- d. The INPT parameter should be displayed and alternating with J_T/C. If this parameter is reading anything else other than J_T/C, press the down arrow until it does.
- e. Press RESET key for several seconds until the temperature (PV) is displayed.
- f. The PV reading is the actual oven temperature and HSP1 is the hi-limit alarm temperature set point. This must be set 10 degrees greater than the DES2000 set point (SP) value.

8. Appendices

8.1. Standard Products Warranty

http://www.despatch.com/pdfs/standard_warranty.pdf.

	8.2.
Standard Products Product Warranty	
Products Covered by this Warranty This warranty (the "Warranty") applies to the following Despatch products: LBB, LAC, LCC, LCD, RAD, RFD, RQD, TAD, TFD, RBC, PBC, PNC, PND, PRVO, PTC, POC and products as specified in Despatch proposal.	<p>tear, service or modifications by other than Despatch authorized technicians, use of the covered product that is inconsistent with the operation manual or labeling, acts of nature (including, without limitation, floods, fire, earthquake, or acts of war or civil emergency), internal or external corrosion, or non-conforming utilities (including, without limitation, electrical, fuel supply, environmental and intake/exhaust installations);</p> <ol style="list-style-type: none">2. repair or replacement of parts or materials designed and intended to be expendable or consumable; refrigerants, filters, lamps;3. routine maintenance; or4. labor costs incurred for troubleshooting, diagnosis, or testing (except for testing required to verify that a covered defective part or material has been repaired).
Parts and Materials Despatch warrants all parts and materials to be free from defects in material and workmanship for a period of: <ol style="list-style-type: none">1. five (5) years from date of shipment for laboratory oven electric heaters;2. two (2) years from date of shipment for Protocol 3 and DES 2000 temperature controllers; and3. one (1) year from the date of shipment, or 2,000 hours of operation, whichever occurs first, for all other components of products covered by this Warranty. During the applicable Warranty period, Despatch will repair or replace, at Despatch's option, parts and materials covered by this Warranty.	Limitations of Liability Despatch shall not, in any event, be liable for indirect, special, consequential, incidental, or punitive damages or penalties of any kind, including, without limitation loss of revenue, profits or business opportunities resulting from interruption of process or production. In no event shall Despatch be liable for damages in excess of the amounts paid by Customer to Despatch with respect to the applicable product(s). This Warranty does not cover, and Despatch shall not be liable for any losses, costs, damages or expenses resulting from delays in diagnosing or repairing the products, supplying or obtaining replacement parts or materials, strikes, labor stoppages or shortages, fires, accidents, government acts or regulations, or any other causes beyond the control of Despatch.
Labor During the first one (1) year of the Warranty period, Despatch will pay labor costs incurred to remove defective parts and materials, and to reinstall repaired or replacement parts or materials; provided, however, that Despatch's obligation to pay such labor costs shall be subject to the limitation that the removal and/or reinstallation service must be performed by a Despatch-authorized technician from Despatch's worldwide network of factory-trained professionals at a location within the contiguous United States.	Non-Compliance By Customer Despatch reserves the right to suspend and withhold service under this Warranty in the event of non-compliance by the Customer to any terms and conditions of this Warranty or the applicable purchase order or invoice. Further, Despatch shall not be liable for any loss of production, expenses, and inconveniences incurred due to such suspension.
Transportation Costs All transportation costs to transport defective parts or materials to Despatch and to transport repaired or replacement parts or materials to Customer shall be the responsibility of the Customer.	Customer Furnished Equipment Warranty Limitation This Warranty does not cover diagnosis or repairs of defects in or caused by, lack of performance of, or fitness for purpose of customer-supplied parts or equipment unless specifically noted in the Despatch written order acceptance confirmation.
Terms and Conditions This Warranty shall be deemed valid and binding upon Despatch if and only if the Customer: <ol style="list-style-type: none">1. installs, loads, operates, and maintains the covered product supplied hereunder in accordance with the instruction manual provided upon delivery and product labeling affixed to the subject equipment;2. if applicable, follows the Emergency Procedure set forth in this Warranty; and3. contacts Despatch's Helpline at 1-800-473-7373 for assistance in diagnosing and troubleshooting the problem immediately upon discovering any damage or malfunction. Despatch's reasonable determination as to whether a repair, replacement, or service is covered by this Warranty shall be final and binding.	Performance Commitment Despatch provides no guarantee of process performance or fitness for purpose, unless specifically noted otherwise in Despatch written order acceptance confirmation. Despatch is providing equipment with design parameters specific only to its equipment.
Exclusions This Warranty DOES NOT cover: <ol style="list-style-type: none">1. damage or malfunctions, or expenses incurred in the process of diagnosing and/or repairing damage or malfunctions, resulting from any of the following: operator error, misuse, abuse, inadequate preventive maintenance, normal wear and	Procedure Upon Discovery of Defects and Emergencies In the event Customer becomes aware of any defect in the applicable products, Customer must immediately: (a) shut off fuel or energy supply (gas and electricity), (b) call for emergency assistance, if needed, and (c) notify Despatch Service.
THE REPRESENTATION AND WARRANTIES SET FORTH HEREIN ARE EXCLUSIVE AND IN LIEU OF, AND CUSTOMER HEREBY WAIVES AND DISCLAIMS RELIANCE UPON, ALL OTHER REPRESENTATIONS AND WARRANTIES OF EVERY KIND WHATSOEVER, WHETHER EXPRESS OR IMPLIED, OR ARISING BY OPERATION OF LAW OR IN EQUITY, OR BY COURSE OF PERFORMANCE OR DEALING OR USAGE OF TRADE, INCLUDING, WITHOUT LIMITATION, ANY IMPLIED WARRANTIES OF MERCHANTABILITY OR OF FITNESS FOR A PARTICULAR PURPOSE.	
THIS WARRANTY IS PERSONAL TO THE CUSTOMER AND MAY NOT BE TRANSFERRED OR ASSIGNED. ALL LIMITATIONS HEREUNDER, HOWEVER, SHALL BE BINDING ON ALL SUCCESSORS AND ASSIGNS OF CUSTOMER.	
<small>Service Phone 800-473-7373; International Phone 952-400-8230; Fax 952-400-8103 e-mail service@despatch.com; www.despatch.com</small>	
<small>BB8 (04/01/14)</small>	

8.3. Optional Equipment

8.3.1. Assemble Oven Stand

1. Install four rubber grommets into holes in the stand (Figure 26).
 - a. For LBB1-69 stands, the rear grommets mount into the forward set of rear holes.
 - b. On LBB2-12 stands the rear grommets mount into the set of holes closest to the rear of the stand.
2. Place the oven on top of the stand. The four embossed areas in the bottom of the oven should center in the grommets.
3. Using the self-drilling screw and large flat washer provided, install through each embossed area as shown below.

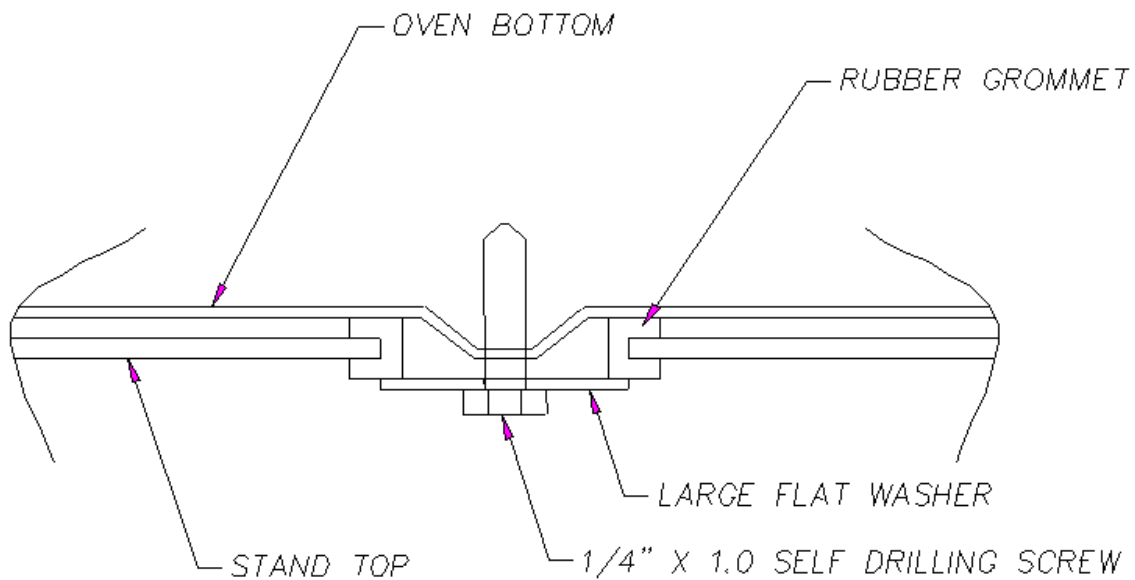

Figure 26. Optional LBB Oven Stand.

8.3.2. End of Cycle (EOC) Timer Option

Use the timer option to count down in hours toward powering the heater OFF (Figure 27).

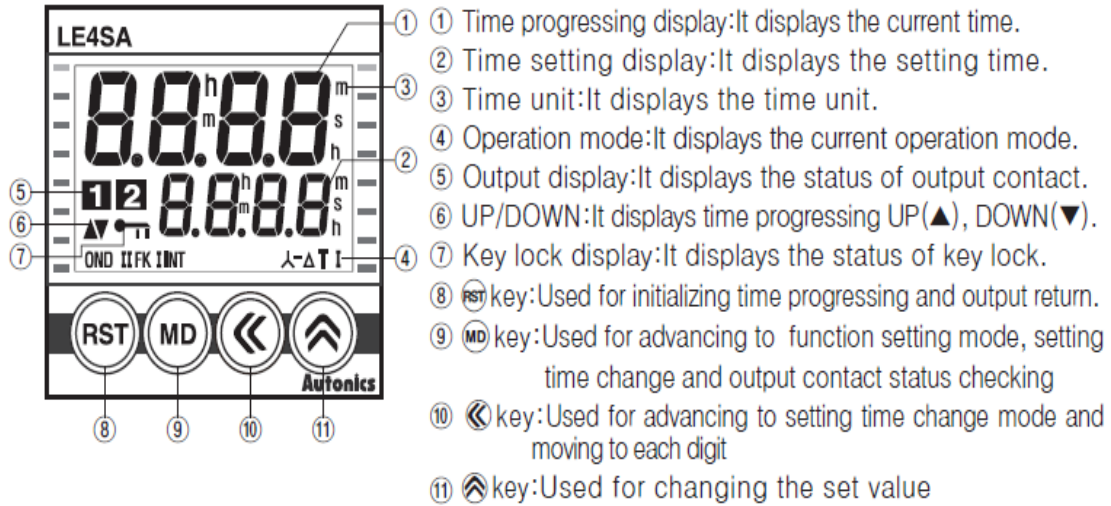



Figure 27. Timer Option Displays and Switches.

	<p>Actual timer may vary from the model pictured (Figure 27).</p>
---	--

8.3.3. Operating the Timer

■ Time setting

● Output operation mode : OND, OND II , INT

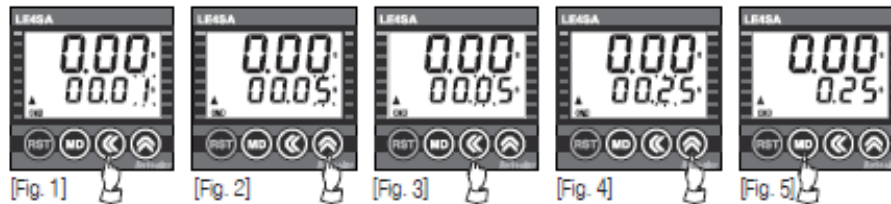

- ① Press \leftarrow key in RUN mode, time set digits will flash. [Fig. 1]
- ② Change setting time by press \leftarrow or \rightarrow keys. [Fig. 2,3,4]
 - \leftarrow key: Shift the setting digits.
 - \rightarrow key: Shift the flashing position value. As press \rightarrow key once, it will increase by 1digit, number will increase faster by press \rightarrow key for over 2sec.
- ③ When the setting is completed, it will be saved and return to RUN mode by pressing MD key. [Fig. 5]

● Output operation mode : FK, FK I

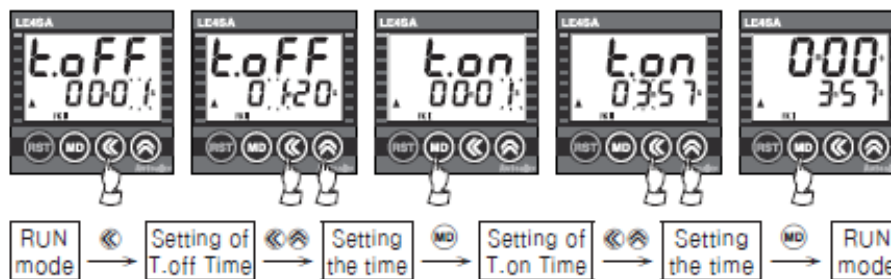

● Output operation mode : Δ , T, T I

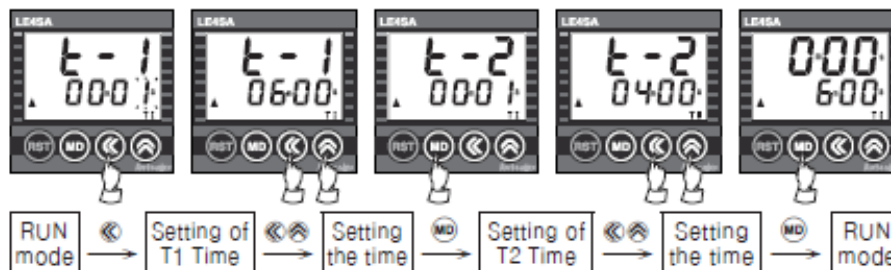

- * Setting time changes can be made during timing operation. Make sure that timing operation is continuously progressed while changing the setting time.
- * If pressing MD key while setting time is shorter than min. setting time, setting value will be flickering three times and it will be returned to setting mode again, not to RUN mode.
- * If there is no additional key operations after entering into setting mode, it will be return to RUN mode. (Setting value is not saved.)
- * Min. Setting time: 0.01 sec. (In case of OND and OND II modes, it is able to set 0 since no min. setting time is applied.)

1) Time Range

Parameter	Time range specification
9.999 ^s (9.999s)	0.010 sec ~ 9.999 sec
99.99 ^s (99.99s)	0.01 sec ~ 99.99 sec
999.9 ^s (999.9s)	0.1 sec ~ 999.9 sec
9999 ^s (9999s)	1 sec ~ 9999 sec
99 ^m 59 ^s (99m59s)	0 min 01 sec ~ 99 min 59 sec
999.9 ^m (999.9m)	0.1 min ~ 999.9 min
9999 ^m (9999m)	1 min ~ 9999 min
99 ^h 59 ^m (99h59m)	0 hour 01 min ~ 99 hour 59 min
99.99 ^h (99.99h)	0.01 hour ~ 99.99 hour
999.9 ^h (999.9h)	0.1 hour ~ 999.9 hour
9999 ^h (9999h)	1 hour ~ 9999 hour

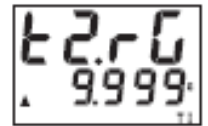
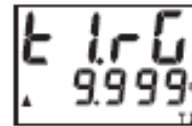

2) One-Shot output time setting



It will be activated when selecting ON Delay 2 [o n d . 2] output operation mode (One-Shot-output mode). (Time setting: 0.01 sec ~ 99.99 sec)

3) Time progress UP/DOWN setting

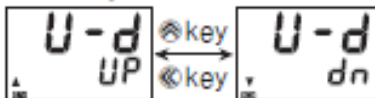

UP [UP]: Time progressed from 0 to setting time.
DOWN [d n]: Time progressed from setting time to 0.

4) Output contact setting

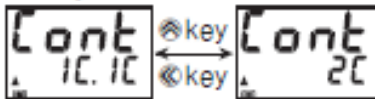

Set the relay contact (No.1, 3, 4 pin) to Instantaneous or Time limit.
[1c. 1c]: Instantaneous 1c, Time limit 1c, [2c]: Time limit 2c.
It is fixed to Time limit 2c in star-delta, Twin and Twin 1 modes.

* If [key] key press on RUN mode, [1c. 1c] or [2c] will be displayed depend on the status of output contact on time setting display.

5) Backlight setting

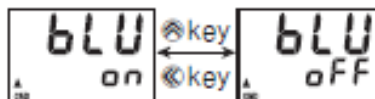

Set Backlight (ON [o n], OFF [o f f]).

6) Key Lock selection

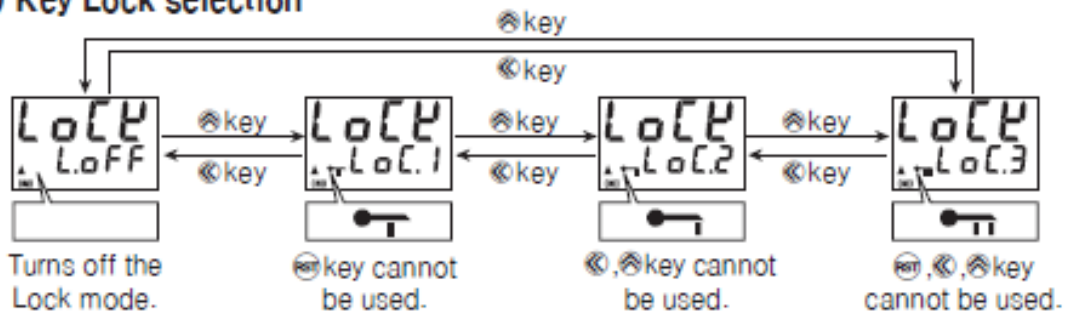

8.3.4. Parameter Default Settings

■ Factory Default

NO.	Parameter		Default
1	Output operation mode	oUt. ñ	oNd
2	Time Range	t.rnG	99.99s
3	Time Up/Down	U-d	UP
4	Output contact	Cont	IC. IC
5	Backlight	bLU	oN
6	Key Lock	LoCK	LoC. I
7	Setting time	-	50.00s

8.3.5. Timer Option with Audible and Visual Alarm

The Timer option sounds an alarm and turns on a light when the timer times out.

- Clear the alarm condition by turning the heater switch OFF.
- Reset the timer before turning heater switch ON.
- Turning the timer switch off also clears the alarm condition, but the heater remains ON.

Each oven schematic (Section 8.5) shows the wiring for this option.

8.3.6. High Alarm Limit Option

The High Alarm Limit option sounds an alarm and turns on a light when a High Limit condition occurs.

- Silence the alarm horn by pressing the alarm silence switch. The light remains ON.
- Clear the High Limit condition to clear the alarm. See Troubleshooting (Section 7) for solutions to High Limit conditions.
- Reset the High Limit instrument whenever it has tripped. Reset the High Limit Instrument by allowing the oven chamber to cool slightly (or by setting the High Limit Instrument by several degrees) and pushing **RESET**.

Each oven schematic (Section 8.5) shows the wiring for this option.

8.4. Part Lists

	<p><i>Find many parts for Despatch ovens online at www.despatch.com/parts.aspx.</i></p>
---	--

8.5. Mechanical Drawing

See mechanical facility drawings included on the manual CD. The drawings included are intended to be reference only and the latest revision may be found online at www.despatch.com.

8.6. Electrical Schematics

See the electrical schematics included on the manual CD. The drawings included are intended to be reference only and the latest revision may be found online at www.despatch.com.

Copyright © 2018 by Despatch Industries.

All rights reserved. No part of the contents of this manual may be reproduced, copied or transmitted in any form or by any means including graphic, electronic, or mechanical methods or photocopying, recording, or information storage and retrieval systems without the written permission of Despatch Industries, unless for purchaser's personal use.

SERVICE AND TECHNICAL SUPPORT

service parts: 1-800-473-7373
international service/main: 1-952-469-8230
service fax: 1-952-469-8193
service@despatch.com
usparts@ltweae.com

GLOBAL HEADQUARTERS

main phone: 1-800-726-0110
international/main: 1-952-469-5424
sales: 1-800-726-0550
international/sales: 1-952-469-8240
sales@despatch.com

www.despatch.com

8860 207th Street West
Minneapolis, MN 55044 USA

Despatch
Thermal Processing Technology 